

Ventec Life Systems®

# Precise Rx™ Pediatric Flowmeter

IRCPF16  
en User Manual



This manual MUST be given to the user of the product BEFORE using this product,  
read this manual and save for future reference.

# Contents

---

<b>1. General</b> .....	<b>1</b>	<b>4. Maintenance</b> .....	<b>12</b>
1.1 Symbols .....	1	4.1 Cleaning the Pediatric Flowmeter .....	12
1.2 Intended Use .....	2	4.2 Humidifier Cleaning and Thermic Disinfection.....	12
1.3 Indications for Use.....	2	<b>5. After Use</b> .....	<b>12</b>
1.4 Contraindications .....	2	5.1 Recycling Information.....	12
1.5 Technical Description .....	2	<b>6. Technical data</b> .....	<b>13</b>
<b>2. Safety</b> .....	<b>3</b>	6.1 Specifications .....	13
2.1 General Guidelines.....	3	<b>7. Warranty</b> .....	<b>14</b>
<b>3. Setup</b> .....	<b>7</b>	7.1 Limited Warranty .....	14
3.1 Handling.....	7		
3.2 Typical Setup .....	7		
3.3 Setup Without a Humidifier Bottle .....	8		
3.4 Setup With a Humidifier Bottle .....	10		
3.5 Setting the Flowrate on the Pediatric Flowmeter.....	11		

## 1. General

### 1.1 Symbols



#### DANGER!

Danger indicates an imminently hazardous situation which, if not avoided, will result in death or serious injury.



#### WARNING!

Warning indicates a potentially hazardous situation which, if not avoided, could result in death or serious injury.



#### CAUTION!

Caution indicates a potentially hazardous situation which, if not avoided, may result in property damage or minor injury or both.





















#### IMPORTANT!

IMPORTANT indicates a hazardous situation that could result in damage to property if it is not avoided.



Gives useful tips, recommendations and information for efficient, trouble-free use.

	<p><b>General Warning Sign</b></p> <p> The background color inside the triangle is yellow on product labels.</p>
	<p><b>Read Manual</b></p> <p> The color of the symbol background is blue on product labels.</p>
	<p><b>No Smoking</b></p> <p> The color of the circle with diagonal bar is red on product labels.</p>
	<p><b>No Open Flame</b></p> <p> The color of the circle with diagonal bar is red on product labels.</p>
	<p><b>Manufacturer</b></p>
	<p><b>Recycle</b></p>
	<p><b>Reference Number</b></p>
	<p><b>Serial Number</b></p>
	<p><b>Indoor Use ONLY</b></p>

	<b>DO NOT use oil or grease</b>
	<b>Keep dry</b>
	<b>Transport and Storage Temperature</b>
	<b>Input Fitting</b>
	<b>Output Fitting</b>

### 1.2 Intended Use

The Precise Rx™ Pediatric Flowmeter is intended to provide supplemental oxygen to patients with low-flow prescriptions in a non-acute setting such as the home or long-term care facility. The device is not intended to be life supporting or life sustaining.



#### **WARNING!**

#### **Risk of Injury or Damage**

Use of this product outside of the intended use and specifications has not been tested and may lead to product damage, loss of product function, or personal injury.

**DO NOT** use this product in any way other than described in the specifications and intended use sections of this manual.

### 1.3 Indications for Use

To provide supplemental oxygen to patients with low-flow prescriptions in a non-acute setting.

### 1.4 Contraindications

There are no known contraindications.

### 1.5 Technical Description

The device is a free standing, non-electrically powered, accessory for connection to the output fitting of a Ventec Life Systems 5 liter output oxygen concentrator that delivers low flow rates of less than one (1) liter per minute to a pediatric patient through a pediatric nasal cannula.

Input oxygen gas at an input pressure of 5.0 +/- 10% PSI and at a minimum flow rate of 2 liters per minute by a compatible Ventec Life Systems 5 liter output oxygen concentrator is delivered to the device input through an external extension tubing accessory. The input gas is routed to an internal bleed orifice for maintaining a minimum flow output load to the oxygen concentrator for maintaining adequate oxygen concentration values of the delivered gas by the oxygen concentrator. The input gas is then supplied to the input of a variable flow rate device and flow meter for flow rate adjustment and subsequent delivery to the output fitting for delivery to a pediatric patient through an externally connected administration accessory, a pediatric nasal cannula.

Oxygen gas output can be delivered to the patient in adjustable flow rates in the continuous flow mode over the range of 1/16 to 3/4 liters per minute.

An externally mounted water humidifier can be used in-line with the output fitting to provide humidification of the oxygen gas delivered to the pediatric patient.

## 2. Safety

### 2.1 General Guidelines

In order to ensure the safe installation, assembly and operation of the device these instructions MUST be followed.



#### **DANGER!**

##### **Risk of Death, Injury or Damage from Fire**

Textiles, oil or petroleum substances, grease, greasy substances and other combustibles are easily ignited and burn with great intensity in oxygen enriched air and when in contact with oxygen under pressure. Smoking during oxygen therapy is dangerous and is likely to result in burns or death. To avoid fire, death, injury or damage:

- DO NOT SMOKE while using this device.
- DO NOT use near OPEN FLAME or IGNITION SOURCES.
- NO SMOKING signs should be prominently displayed.
- Keep all open flames, matches, lighted cigarettes, electronic cigarettes, or other sources of ignition at least 10 ft (3 m) away from any concentrator or any oxygen carrying accessories such as cannulas or tanks.



#### **DANGER!**

##### **Risk of Death, Injury or Damage from Fire**

Textiles, oil or petroleum substances, grease, greasy substances and other combustibles are easily ignited and burn with great intensity in oxygen enriched air and when in contact with oxygen under pressure. To avoid fire, death, injury or damage:

- Avoid creation of any spark near oxygen equipment. This includes sparks from static electricity created by any type of friction.
- Use only oxygen compatible water-based lotions or salves before and during oxygen therapy. To verify, refer to the lotion/salve container for oxygen compatible water-based statement. If necessary, contact the manufacturer. DO NOT use any lubricants on concentrator or accessory fittings unless recommended by Ventec Life Systems.
- Keep the oxygen tubing, cord, AC adapter, and concentrator out from under such items as blankets, bed coverings, chair cushions, clothing, and away from heated or hot surfaces including space heaters, stoves, and similar electrical appliances.
- Make sure concentrator is off when not in use.



**DANGER!**

**Risk of Death, Injury or Damage**

Improper use of the product may cause death, injury or damage. This section contains important information for the safe operation and use of this product.

- DO NOT use this product or any available optional equipment without first completely reading and understanding these instructions and any additional instructional material such as user manuals, service manuals or instruction sheets supplied with this product or optional equipment.
- If you are unable to understand the warnings, cautions or instructions, contact a healthcare professional, dealer or technical personnel before attempting to use this equipment.
- Check ALL external components and carton for damage. In case of damage, or if the product is not working correctly, contact a technician or Ventec for repair.
- This product is intended to be set up by adults or under adult supervision only after reading and understanding the instructions and warnings of this user manual.
- THE INFORMATION IN THIS DOCUMENT IS SUBJECT TO CHANGE WITHOUT NOTICE.



**CAUTION!**

Federal (statutory) law restricts this device sale to or on the order of a medical practitioner licensed by a governmental agency where he/she practices.

- ONLY a licensed medical practitioner may order the purchase or use of this device.



**DANGER!**

**Risk of Injury or Death**

To avoid choking or ingestion of chemicals from airway contamination:

- DO NOT use the concentrator in the presence of pollutants, smoke, fumes, flammable anesthetics, cleaning agents, or chemical vapors.



**WARNING!**

**Risk of Injury or Damage**

To prevent injury or damage from misuse:

- NEVER leave concentrator unattended when plugged in.
- Make sure concentrator is off when not in use.



**WARNING!**  
**Risk of Injury or Damage**

- Ventec Life Systems products are specifically designed and manufactured for use in conjunction with Ventec Life Systems accessories. Accessories designed by other manufacturers have not been tested by Ventec Life Systems and are not recommended for use with Ventec Life Systems products
- No modification of this equipment is allowed.



**WARNING!**  
**Risk of Injury**

A change in altitude may affect total oxygen available for use. To prevent oxygen deprivation:

- Consult a physician before traveling to higher or lower altitudes to determine if the patient's flow settings should be changed.



**WARNING!**  
**Risk of Injury or Death**

To prevent injury or death from product misuse:

- Closely supervise when this device is used by or near children or physically-challenged individuals.
- Monitor patients using this device who are unable to hear or see alarms or communicate discomfort.
- Keep out of reach of children and away from pets.



**DANGER!**  
**Risk of Injury or Death**

While Ventec Life Systems strives to produce the best oxygen devices in the market today, the oxygen concentrator can fail to produce oxygen due to power failure or device malfunction.

- Contact your provider for a backup source of oxygen for a pediatric patient.
- Do not connect the input of the device to any other oxygen delivery device other than an Ventec Life Systems 5 liter output oxygen concentrator, otherwise serious injury can occur.
- The Pediatric Flowmeter is designed for an input pressure of 5 psi (34.5 kPa) only. The flowmeter is applicable only with Ventec concentrators with 5 psi (34.5 kPa) output pressure.



**WARNING!**  
**Risk of Injury or Damage**

To prevent injury or damage during use:

- For optimum performance, Ventec Life Systems recommends that the concentrator be on and running for a minimum of 30 minutes. Shorter periods of operation may reduce maximum product life.
- For proper oxygen output, the concentrator should be used in an upright position.
- The Pediatric Flowmeter cannot be used in conjunction with PAP, Bi-Level, mechanical ventilator or other such devices.



**WARNING!**  
**Risk of Injury or Damage**

The Pediatric Flowmeter is specifically designed to eliminate routine preventive maintenance. To prevent injury or damage:

- Only professionals of the healthcare field or persons fully conversant with this process such as factory trained personnel should perform service, except for tasks described in this manual.
- Users should contact your dealer or Ventec Life Systems for service.
- DO NOT disassemble. Refer servicing to qualified service personnel. There are no user serviceable parts.



**CAUTION!**  
**Risk of Damage**

To prevent damage from liquid ingress:

- If the device is not working properly, if it has been dropped or damaged, or dropped into water, call equipment provider/qualified technician for examination and repair.
- NEVER drop or insert any object or liquid into any opening.
- Use of this device with a humidifier located on the inlet gas stream may impair performance or damage the Pediatric Flowmeter. Use of a humidifier is limited to use only on the output gas being delivered by the Pediatric Flowmeter to the patient. Refer to Setup With a Humidifier Bottle.



### 3. Setup

#### 3.1 Handling

##### Unpacking and Inspection

1. Check for any obvious damage to the carton or its contents. If damage is evident, notify your carrier/dealer for further instruction.
2. Remove all the loose packing from the carton.
3. Carefully remove all components from the carton.
  - Packing materials and carton should be kept for future use during storage or transportation.
4. Examine exterior of the flowmeter for nicks, dents, scratches or other damages. Inspect all components.

##### Storage

1. Store the repackaged flowmeter in a dry area.
2. DO NOT place other objects on top of the repackaged device.

The IRCPF16 includes:

DESCRIPTION	QUANTITY
Flowmeter Stand	1
Crush-Proof Tubing (CP) — 21 ft (6.3 m)	1
Crush-Proof Tubing — 7 ft (2.1 m) total	2
Humidifier Bottle Adapter	1
Humidifier Bottle	1
Connector	1
Packaging (Carton)	1
Instructions	1

#### 3.2 Typical Setup



##### WARNING!

- ONLY use a pediatric nasal cannula with this device.
- Place the pediatric nasal cannula on patient only after all tubing connections have been made. Possible water feedback through the tubing could occur if this sequence is not followed.
- When adjusting the Pediatric Flowmeter, the flowmeter on the oxygen concentrator MUST be set at 2.0 L/min. Failure to comply with this procedure will cause incorrect flow rates to the patient.
- Ventec Life Systems recommends that crush proof oxygen tubing be used with this product.



##### WARNING!

- If use of a humidifier bottle is not prescribed, the oxygen tubing is not to exceed 25 ft (7.6 m) in total length from the Pediatric Flowmeter to the patient, and the total length of ALL tubing CANNOT exceed 50 ft (15.2 m).
- If use of a humidifier bottle is prescribed, the oxygen tubing is not to exceed 25 ft (7.6 m) in total length from the humidifier bottle to the patient, and the total length of ALL tubing for the Pediatric Flowmeter CANNOT exceed 39 ft (11.8 m).

### 3.2 Typical Setup

1. Turn the Ventec Life Systems 5 liter output concentrator on. An indicator light on the control panel will illuminate. Refer to the concentrator user manual for setup and use.
2. Set the oxygen concentrator to 2.0 L/min.
3. Place the Pediatric Flowmeter stand on table top.
4. Turn the Pediatric Flowmeter knob counterclockwise to the fully open position.
5. Allow concentrator to run a minimum of 30 minutes to ensure proper concentration level. Check and readjust the oxygen concentrator to 2.0 L/min.

Optional Accessories and replacement parts available:

- Humidifier — WestMed #0480
- Oxygen Supply Tubing 7 ft (2.1 m) — Ventec Life Systems Part Number 1071207
- Oxygen Supply Tubing 21 ft (6.3 m) — Ventec Life Systems Part Number 2003110
- Bottle Adapter — Ventec Life Systems Part Number 2000503

Pediatric nasal cannula accessory not supplied with unit.

### 3.3 Setup Without a Humidifier Bottle

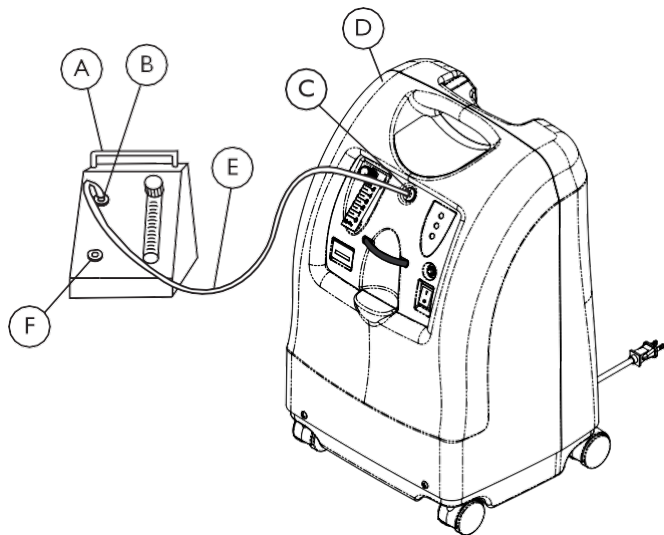

<b>A</b>	Pediatric Flowmeter
<b>B</b>	Input Fitting on Pediatric Flowmeter
<b>C</b>	Output Fitting of Concentrator
<b>D</b>	Concentrator
<b>E</b>	7 ft (2.1 m) Oxygen Tubing
<b>F</b>	Output Fitting of Flowmeter

1. Connect a 7 ft (2.1 m) oxygen tubing (E) from the output fitting (C) of the concentrator (D) to the input fitting (B) of the Pediatric Flowmeter (A).
2. Connect a 21 ft (6.3 m) [25 ft (7.6 m) maximum] length oxygen tubing (not shown) to the output fitting (F) of the Pediatric Flowmeter (A).
3. Attach the opposite end of the oxygen tubing (not shown) to a pediatric nasal cannula using an appropriate oxygen tubing connector as applicable (not shown).

### 3.4 Setup With a Humidifier Bottle

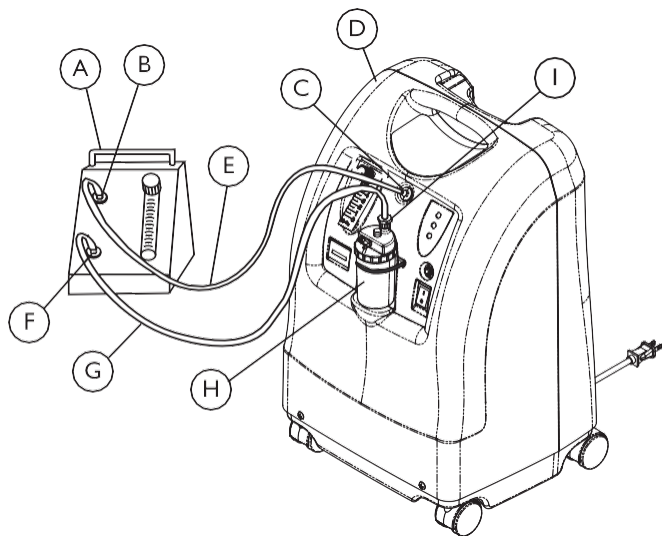

1. Connect a 7 ft (2.1 m) maximum oxygen tubing (E) from the output fitting (C) of the concentrator (D) to the input fitting (B) of the Pediatric Flowmeter (A).
2. Follow the directions supplied by the humidifier bottle (H) manufacturer for instructions on filling and connecting to oxygen tubing.
3. After filling the humidifier bottle with water, place it in the humidifier compartment on the Ventec Life Systems concentrator (D) (see concentrator user manual for mounting the bottle).

<b>A</b>	Pediatric Flowmeter
<b>B</b>	Input Fitting of Pediatric Flowmeter
<b>C</b>	Output Fitting of Concentrator
<b>D</b>	Concentrator
<b>E</b>	7 ft (2.1 m) Oxygen Tubing from Concentrator to Flowmeter
<b>F</b>	Output Fitting of Flowmeter
<b>G</b>	7 ft (2.1 m) Oxygen Tubing from Flowmeter to Concentrator
<b>H</b>	Humidifier Bottle
<b>I</b>	Inlet of Humidifier Bottle

4. Connect 7 ft (2.1 m) maximum oxygen tubing (G) from the Pediatric Flowmeter (A) output fitting (F) to the inlet of the humidifier bottle (I) (using an appropriate adapter if applicable).
5. Connect a 21 ft (6.3 m) [25 ft (7.6 m) maximum] oxygen tubing to the outlet of the humidifier bottle (not shown).
6. Attach the opposite end of the oxygen tubing to a pediatric nasal cannula using an appropriate oxygen tubing connector (not shown).



#### CAUTION!

- DO NOT coil crush resistant oxygen tubing on COLD floor or condensation will form inside the tubing.

### 3.5 Setting the Flowrate on the Pediatric Flowmeter



#### WARNING!



- DO NOT select a different setting unless the patient's physician has prescribed a change in the flowrate of the Pediatric Flowmeter.

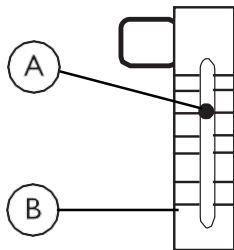
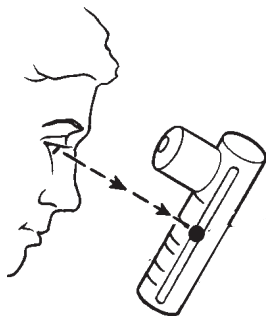

#### CAUTION!

- DO NOT allow water or other substances to enter flowmeter openings. DO NOT submerge the flow stand, flowmeter or tubing in water.



1. Set the Pediatric Flowmeter as prescribed by the patient's physician.  
 The flowrate on the standard concentrator flowmeter will drop below the 2.0 L/min setting after the flowmeter is installed and operating. The Pediatric Flowmeter setting should be reassessed periodically.
2. When adjusting the flow, center the ball **(A)** of the Pediatric Flowmeter **(B)** with the line of the prescribed flowrate. When viewing from the proper angle, the graduation lines on the front and the back of the flowmeter will be in alignment with the center of the ball.
3. Check for oxygen delivery by placing the nasal prongs of the pediatric nasal cannula under the surface of a half-full glass of water only when the oxygen is flowing and look for bubbles indicating proper operation. Wipe any excess water off the nasal prongs when finished before placing on the patient.
4. Place pediatric nasal cannula on the patient.  
 The proper placement and positioning of the prongs of the pediatric nasal cannula in the nose is critical to the amount of oxygen delivered to the respiratory system of the patient.

## 4. Maintenance

### 4.1 Cleaning the Pediatric Flowmeter

1. The unit exterior can be cleaned with warm soapy water. Wipe with a soft, damp cloth and dry thoroughly.
2. The humidifier bottle **MUST** be cleaned after each use.
3. Humidifier bottle and tubing **MUST** be changed after each patient.



#### CAUTION!

- DO NOT allow water or other substances to enter flowmeter openings. DO NOT submerge flow stand, flowmeter or tubing.

The Pediatric Flowmeter is specifically designed to minimize routine preventive maintenance.

If damage to the unit is suspected, or if for any reason flow accuracy is in question, Ventec Life Systems recommends returning the unit to Ventec Life Systems for repair by qualified personnel.

### 4.2 Humidifier Cleaning and Thermic Disinfection

Clean and disinfect the oxygen humidifier daily to reduce limestone deposits and eliminate possible bacterial contamination. Follow the instructions provided by the manufacturer. If none are provided, follow these steps:

1. Wash humidifier in soapy water and rinse with a solution of ten parts water and one part vinegar.
2. Rinse thoroughly with hot water.
3. Air dry thoroughly.

 To limit bacterial growth, air dry the humidifier thoroughly after cleaning when not in use. Refer to Set Up for use.

## 5. After Use

### 5.1 Recycling Information

This product has been supplied from an environmentally aware manufacturer.

Follow local governing ordinances and recycling plans regarding disposal of the device or accessories normally used in operation. The device does not generate waste or residue in operation.

Any accessories not part of the device **MUST** be handled in accordance with the individual product marking for disposal.

## 6. Technical Data

### 6.1 Specifications

INPUT PRESSURE RATING:	5 ± 0.5 psi (34.5 ± 3.45 kPa)
OXYGEN INPUT:	2 L/min, 85% to 95.6% oxygen
MAXIMUM OUTPUT PRESSURE:	4.0 psi (27.6 kPa)
OXYGEN OUTPUT FLOW:	0–3/4 L/min (0–750 cc/min)
FLOW ADJUSTABLE IN INCREMENTS:	1/16 L/min (50 cc/min)
FLOW ACCURACY:	± 5% of full scale for flows from 50cc to 250cc, and ± 10% of full scale for flows above 250cc to 750cc
WIDTH:	4.7 in (11.94 cm)
HEIGHT:	5.7 in (14.48 cm) with pad and handle; 4.7 in (11.94 cm) without pad and handle
DEPTH:	4.7 in (11.94 cm)
WEIGHT:	1.86 lb (0.8 kg)
SHIPPING WEIGHT:	2.40 lb (1.1 kg)
OPERATING TEMPERATURE RANGE:	50° to 95° F (10° to 35° C)
STORAGE TEMPERATURE RANGE:	–20° to 158° F (–29° to 70° C)

 Measurement uncertainty is included in the device specification.  
 All conditions at ambient temperature and pressure, dry.

## **7. Warranty**

### **7.1 Limited Warranty**

NOTE: THE WARRANTY BELOW HAS BEEN DRAFTED TO COMPLY WITH FEDERAL LAW APPLICABLE TO PRODUCTS MANUFACTURED AFTER JULY 4, 1975.

This warranty is extended only to the original purchaser who purchases this product when new and unused from Ventec Life Systems Corporation or a dealer. This warranty is not extended to any other person or entity and it is not transferable or assignable to any subsequent purchaser or owner. Coverage under this warranty will end upon any such subsequent sale or other transfer of title to any other person. This warranty gives you specific legal rights and you may also have other legal rights which may vary from state to state.

Ventec Life Systems Corporation warrants its Pediatric Flowmeter when purchased new and unused to be free from defects in materials and workmanship for a period of one year from date of purchase from Ventec Life Systems or a dealer, with a copy of the seller's invoice required for coverage under this warranty.

If within such warranty periods any such product shall be proven to Ventec Life Systems Corporation's satisfaction to be defective, such product shall be repaired or replaced, at Ventec Life Systems Corporation's option. This warranty only applies to the labor for repairs performed by the Ventec Life Systems Service Department or Ventec Life Systems Authorized Service Centers. It does not apply to the labor performed by the purchaser or user. This warranty does not include normal wear and tear or shipping charges. Ventec Life Systems Corporation's sole obligation and your exclusive remedy under this warranty shall be limited to such repair or replacement. Routine maintenance items, such as filters, are excluded from this warranty.

For warranty service, please contact Ventec Life Systems Corporation's Service Department at the toll free number on the back cover. Upon receiving notice of an alleged defect in a product, Ventec Life Systems Corporation will issue a serialized return authorization. It shall then be the responsibility of the purchaser to return the entire unit or remove, at purchaser's cost, the defective component part(s) identified, pack the component part(s) in a manner to avoid shipping damage and to ship the component part(s) to either Ventec Life Systems Corporation's plant or service center as specified by Ventec Life Systems Corporation in advance. Defective component part(s) MUST be returned for warranty inspection using the serial number as identification within thirty days of return authorization date. DO NOT return products to our factory without prior consent. C.O.D. shipments will be refused; please prepay shipping charges.



LIMITATIONS AND EXCLUSIONS: THE FOREGOING WARRANTY SHALL NOT APPLY TO PRODUCTS SUBJECTED TO NEGLIGENCE, ACCIDENT, IMPROPER OPERATION, MAINTENANCE OR STORAGE, SOOT OR SMOKE-FILLED ENVIRONMENTS, OR OTHER THAN NORMAL APPLICATION, USE OR SERVICE, OR TO PRODUCTS MODIFIED WITHOUT VENTEC LIFE SYSTEMS CORPORATION'S EXPRESS WRITTEN CONSENT (INCLUDING, BUT NOT LIMITED TO, MODIFICATION THROUGH THE USE OF UNAUTHORIZED PARTS OR ATTACHMENTS) OR TO PRODUCTS DAMAGED BY REASON OF REPAIRS MADE TO ANY COMPONENT WITHOUT THE SPECIFIC CONSENT OF VENTEC LIFE SYSTEMS CORPORATION OR TO PRODUCTS DAMAGED BY CIRCUMSTANCES BEYOND VENTEC LIFE SYSTEMS CORPORATION'S CONTROL.

THE FOREGOING EXPRESS WARRANTY IS EXCLUSIVE AND IN LIEU OF ANY OTHER WARRANTIES WHATSOEVER, WHETHER EXPRESS OR IMPLIED, INCLUDING THE IMPLIED WARRANTIES OF MERCHANTABILITY AND FITNESS FOR A PARTICULAR PURPOSE, AND THE SOLE REMEDY FOR VIOLATIONS OF ANY WARRANTY WHATSOEVER, SHALL BE LIMITED TO REPAIR OR REPLACEMENT OF THE DEFECTIVE PRODUCT PURSUANT TO THE TERMS CONTAINED HEREIN. THE APPLICATION OF ANY IMPLIED WARRANTY WHATSOEVER SHALL NOT EXTEND BEYOND THE DURATION OF THE EXPRESS WARRANTY PROVIDED HEREIN. VENTEC LIFE SYSTEMS SHALL NOT BE LIABLE FOR ANY CONSEQUENTIAL OR INCIDENTAL DAMAGES WHATSOEVER.

SOME STATES DO NOT ALLOW THE EXCLUSION OR LIMITATION OF INCIDENTAL OR CONSEQUENTIAL DAMAGE, OR LIMITATION OF HOW LONG AN IMPLIED WARRANTY LASTS, SO THE ABOVE EXCLUSION AND LIMITATION MAY NOT APPLY TO YOU.

THIS WARRANTY SHALL BE EXTENDED TO COMPLY WITH STATE/PROVINCIAL LAWS AND REQUIREMENTS.

NOTES:

NOTES:

**Ventec Life Systems, Inc.**

22002 26th Ave SE Bothell, WA 98021 United States

844-698-6276

[www.venteclife.com](http://www.venteclife.com)



Manufacturer

**Ventec Life Systems**, Inc.

22002 26th Ave SE Bothell, WA 98021 USA

