

User Manual

Luna[®] G3 BPAP 25A

LG3700



REACTHEALTH

Table of Contents

1. Introduction	1
2. Symbols	1
2.1 Control Buttons	1
2.2 Device Symbols	1
3. Warning, Caution and Important Tip	4
4. Intended Use	4
5. Contraindications	5
6. Specifications	6
7. Available Therapies	11
8. Glossary	12
9. Model	13
10. Package Contents	14
11. System Features	15
12. First Time Setup	16
12.1 Placing the Device	16
12.2 Installing the Reusable Air Filter / Optional Disposable Ultra-Fine Filter and Filter Cap	17
12.3 Connecting to Power	18
12.4 Connecting to Power Cord Locker	19
12.5 Assembling the Tubing / Heated Tubing and Mask	20
12.6 Using Oxygen with the Device	22
12.7 Inserting the SD Card (Only for the device that equipped with SD card)	23
12.8 Starting Treatment	23
13. Routine Use	24
13.1 Connecting the Tubing	24
13.2 Adjusting the Tubing	24
13.3 Turning on the Airflow	24
13.4 Heating the Water	24
13.5 Using the Ramp Feature	24
13.6 Accessing the iCode	25
13.7 Turning the Device Off	25
14. Heated Humidifier	25
14.1 Filling the Water Chamber	25
14.1.1 Removing the Water Chamber	25
14.1.2 Filling Water	26
14.1.3 Returning the Water Chamber	27
14.2 Emptying the Water Chamber	27
14.3 Setting the Humidity Level	28
15. Using the Cellular Module	28

16. Navigating the Patient Menu	30
16.1 Steps to Navigate the Patient Menu	30
16.1.1 Accessing the Main Interface	30
16.1.2 Bringing up the Initial Setup Interface	31
16.1.3 Selecting Options	31
16.1.4 Adjusting Options	32
16.1.5 Confirming Adjustments	32
16.1.6 Turning Pages	32
16.1.7 Exiting the Patient Menu	33
16.2 Options of the Patient Menu and Corresponding Descriptions	34
17. Alert	36
18. Cleaning and Disinfection	37
18.1 Cleaning	38
18.1.1 Cleaning the Water Chamber	38
18.1.2 Cleaning the Transfer Box	39
18.1.3 Cleaning the Mask and Headgear	39
18.1.4 Cleaning the Enclosure	39
18.1.5 Cleaning the Tubing	40
18.1.6 Cleaning and Replacing the Reusable Air Filter / Optional Disposable Ultra-Fine Filter	41
18.2 Disinfection	42
19. Traveling	43
19.1 Traveling with the Device	43
19.2 Traveling by airplane	44
20. Reordering	44
21. Technical Support	44
22. Disposal	45
23. Troubleshooting	45
23.1 Common Problems in Patients and Corresponding Solutions	45
23.2 Common Problems in the Device and Corresponding Solutions	47
24. Information of QoS	48
25. EMC Requirements	49
26. Limited Warranty	55

1. Introduction

Thank you for your purchase of the Luna® G3 BPAP 25A. This User Manual will provide you with information about your device. Please read it carefully. If you experience any difficulties or problems during use, please contact your healthcare provider or physician. If the package is damaged, contact your equipment provider.

2. Symbols

2.1 Control Buttons



Home Button



Start/Stop Button



Knob

2.2 Device Symbols



Follow Instructions for Use



Consult instructions for use



Type BF Applied Part (mask)



Class II (Double Insulated)



For indoor use only



AC Power



DC Power

IP22

≥ 12.5 mm Diameter, Dripping (15° tilted)



Electric shock hazard



Hot Surface



Serial Number



Manufacturer



Made in China, date of manufacture



Use-by Date



Do not use if package is damaged and consult instructions for use



Disassembly is prohibited



Maximum water level



Batch code



Non-Ionizing Radiation



SD Card



Waste Electrical and Electronic Equipment



Air Inlet



Air Outlet



Caution



MR Unsafe



Complies with RTCA DO-160 section 21, category M.



Medical Device



Prescription only



Catalogue number



Unique device identifier



Model Number



Temperature Limit



Humidity Limit

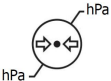

Atmospheric Pressure Limit

3. Warning, Caution and Important Tip

⚠ WARNING!

Indicates the possibility of injury to the user or operator.

CAUTION!

Indicates the possibility of damage to the device.

IMPORTANT TIP!

Indicate the possibility that such operation may affect the effectiveness or ease of use of the device.

Warnings, Cautions, and Important Tips appear throughout this manual as they apply.

4. Intended Use

The Luna® G3 BPAP 25A is a Bi-level PAP (Bi-level Positive Airway Pressure) device designed for the treatment of Obstructive Sleep Apnea (OSA). The integrated humidifier is indicated for the humidification and warming of air from the flow generator device. These devices are intended for single-patient re-use in the home environment or for multi-patient re-use in the hospital/institutional environment. It is to be used on adult patients > 66 lbs / 30 kg for whom CPAP therapy has been prescribed. The system can deliver bi-level therapy or auto bi-level therapy.

⚠ WARNINGS!

- This device is intended for adult use only.
- This device is not intended for life support.
- The instructions in this manual are not intended to supersede established medical protocols.
- To ensure that you receive the safe, effective therapy prescribed for you, use only REACT HEALTH accessories.
- Do not bring the device or accessories into a Magnetic Resonance (MR) environment as it may cause unacceptable risk to the patient or damage to the device or MR medical devices. The device and accessories have not been evaluated for safety in an MR environment.
- Do not use the device or accessories in an environment with electromagnetic equipment such as CT scanners, Diathermy, RFID and electromagnetic security systems (metal detectors) as it may cause unacceptable risk to the patient or damage to the device. Some electromagnetic sources may not be apparent, if you notice any unexplained changes in the performance of this device, if it is making unusual or harsh sounds, disconnect the power cord and discontinue use. Contact your healthcare provider.
- Do not introduce fragrances or aromatherapy odors into the interior of the machine.
- If you discover foreign objects inside the device, tube, or mask, you should immediately stop using the device and contact the provider of your device.

CAUTIONS!

- U. S. federal law restricts this device to sale by or on the order of a physician.
- The patient is the intended operator.
- The device is intended for use by operators trained or experienced in similar equipment.

IMPORTANT TIPS!

- Read and understand the entire user manual before operating this system. If you have any questions concerning the use of this system, contact your healthcare provider or physician.

5. Contraindications

If you have any of the following conditions, tell your physician before using this device:

- Insufficient respiratory drive to endure brief interruptions in non-invasive ventilation therapy
- Acute sinusitis or otitis media
- Epistaxis causing a risk of pulmonary aspiration
- Conditions predisposing to a risk of aspiration of gastric contents
- Impaired ability to clear secretions
- Hypotension or significant intravascular volume depletion
- Pneumothorax or pneumomediastinum
- Recent cranial trauma, cerebrospinal fluid leak or surgery
- Obviously uncooperative or extremely tense

The following side effects may occur during treatment:

- Dryness of the mouth, nose and throat
- Abdominal bloating
- Ear or sinus discomfort
- Eye irritation
- Skin irritation due to the use of a mask
- Chest discomfort

IMPORTANT TIPS!

- An irregular sleep schedule, alcohol consumption, obesity, sleeping pills, or sedatives may aggravate your obstructive sleep apnea symptoms.
- React Health recommends use of React Health supplied masks, and only masks compliant with ISO 17510:2015.

CAUTION!

- Contact your physician if symptoms of obstructive sleep apnea reoccur. Contact your physician if you have any questions concerning your therapy.

6. Specifications

Device Size

Dimensions (L x W x H): 265 mm × 145 mm × 114 mm

Weight: 1.7 kg

Water capacity: To maximum fill line 360 mL

Product Use, Transport and Storage

Operation	Transport and Storage
Temperature: 5°C to 35°C (41°F to 95°F)	-25°C to 70°C (-13°F to 158°F)
Humidity: 15% to 93% Non-condensing	15% to 93% Non-condensing
Atmospheric Pressure: 760 to 1060 hPa	760 to 1060 hPa
Altitude: Sea level to 2300 m	Sea level to 2300 m

Heated Humidifier

Humidifier Settings: Off, Auto, 1 to 5 (The corresponding heating plate temperature is from the current ambient temperature to 154.4°F / 68°C)

Note: For settings 1 to 5, the higher the setting, the stronger the humidification and heating ability.

Humidifier Output: Not less than 15 mg H₂O/L

Environmental Conditions: Maximum airflow, 35°C, 15% relative humidity

Maximum Operating Pressure: 40 cmH₂O

Pressure Drop with Humidifier: < 0.4 hPa at 60 LPM flow

Maximum Delivered Gas Temperature: ≤ 43°C

Mode of Operation

Continuous

Work Mode

CPAP, AutoCPAP, S, AutoS

SD Card

The SD card is capable of storing patient treatment data and error information.

AC Power Consumption

100 V – 240 V \sim , 50 Hz / 60 Hz, 2 A

Power to Heated Tubing Communications Port

24 V --- 18 W

Type of Protection Against Electric Shock

Class II Equipment

Degree of Protection Against Electric Shock

Type BF Applied Part

Degree of Protection Against Ingress of Water

IP22

Pressure Range4 to 25 cmH₂O (in 0.5 cmH₂O increments)Under single fault conditions, ≤ 30 cmH₂O for CPAP and AutoCPAP mode, ≤ 40 cmH₂O for the rest modes.**Pressure Display Accuracy**±(0.8 cmH₂O + 4%)**Static Pressure Stability at 10 cmH₂O**±0.5 cmH₂O**Dynamic Pressure Stability**

Pressures (cmH ₂ O)	10 BPM	15 BPM	20 BPM
6.5	±0.5	±0.5	±0.5
10	±1	±1	±1
20	±1	±1	±1

Device with humidification and 22 mm Tubing or Heated Tubing.

Ramp

The ramp time ranges from 0 to 60 minutes.

The A-weighted sound pressure level and sound power level

When operating at a pressure of 10 hPa, the device's sound pressure level and sound power level shall not exceed the values listed in the table below.

Sound Pressure Level	Uncertainty	Sound Power Level	Uncertainty
26 dB(A)	2 dB(A)	34dB(A)	2 dB(A)

Note: Declared dual-number noise emission values in accordance with ISO 4871:1996.

Maximum Flow

Test Pressures (cmH ₂ O)	4	10	15	20	25
Measured Pressure at the Patient Connection Port (cmH ₂ O)	3	9	14	19	24
Average Flow at the Patient Connection Port (L/min)	90	150	150	150	150

When the working pressure is set to the values listed in the table, the average flow rate at the patient end should be greater than 80% of the corresponding flow value in the table.

Air Tubing

Air tubing	Length	Inner diameter
Tubing	6 ft. (1.83 m)	19 mm
Heated Tubing	6 ft. (1.83 m)	19 mm

The Form and the Dimensions of the Patient Connection Port

The 22 mm conical air outlet complies with ISO 5356-1.

Reusable Air Filter

Type	Material	Average arrestance
Reusable Air Filter	Polyurethane	> 20% for 10 micron dust

Disposable Ultra-fine Filter (Optional)

Type	Material	Average arrestance
Disposable Ultra-fine Filter	Polypropylene	> 95% for 5 micron dust

Cellular Module**Thales**

Transportation Requirements	Shock, severe vibration, and moisture should be avoided in transportation
Frequency Bands	LTE Band 1, 2, 3, 4, 5, 8, 12, 13, 18, 19, 20, 25, 26, 27, 28, 66, 85
Communication Mode	LTE Cat M1/ NB1/2
Effective Radiated Power LTE	LTE Cat M1/ NB1: $\leq +20$ dBm ± 2 dB, Class 5
FCC ID	QIPEXS62-W

¹ The LTE bands supported by Cellular Module are defined in above, while the following Table 1 describes the Receiver Input Sensitivity.

Table 1 Receiver Input Sensitivity

Parameter	Conditions	Min.	Typical	Unit
BW: 5 MHz, UL: Modulation: QPSK; NRB=6; DL: Modulation: QPSK; NRB=4	LTE 2100 Band 1	-103	-107	dBm
	LTE 1800 Band 2	-101	-106	dBm
	LTE 1900 Band 3	-100	-103	dBm
	LTE AWS-1 Band 4	-103	-107	dBm
	LTE 850 Band 5	-101.5	-103.5	dBm
	LTE 900 Band 8	-100.5	-105.5	dBm
	LTE 700 Band 12	-100	-108	dBm
	LTE 700 Band 13	-100	-106	dBm
	LTE 800 Band 18	-103	-105	dBm
	LTE 800 Band 19	-103	-107.5	dBm
	LTE 800 Band 20	-100.5	-107.5	dBm
	LTE 1900 Band 25	-101	-106.5	dBm
	LTE 800 Band 26	-101	-105	dBm
	LTE 800 Band 27	-101.5	-108	dBm
	LTE 700 Band 28	-101.5	-107.5	dBm
	LTE AWS-3 Band 66	-99	-107	dBm
LTE 700 Band 85	-99.2	-107.5	dBm	

FCC Requirements

The product complies with parts 15, 22, 24, 27, & 90 of the FCC Rules and ICES-003 Class B. Operation is subject to the following two conditions:

- (1) The product may not cause harmful interference.
- (2) The product must accept any interference received, including interference that may cause undesired operation.

Summary of Test Results

The EUT has been tested according to the following specifications:

Test Item	Test Requirement	Test Method	Result
Conducted Emission	FCC 47 CFR Part 15.107 ICES-003 Issue 6 Section 6.1	ANSI C63.4-2014	PASS
Radiated Emission	FCC 47 CFR Part 15.109 ICES-003 Issue 6 Section 6.2		PASS
Radiofrequency Radiation Exposure Evaluation	FCC 47 CFR Part 1 Subpart I RSS-102 Issue 5	--	PASS
Equivalent Isotropic Radiated Power (EIRP)	FCC 47 CFR Part 22 FCC 47 CFR Part 24 FCC 47 CFR Part 27 FCC 47 CFR Part 90 RSS-130 Issue 2 RSS-132 Issue 3 RSS-133 Issue 6 RSS-139 Issue 3 RSS-Gen Issue 5	ANSI C63.26-2015 & KDB 971168 D01v03r01 ANSI/TIA-603-E-2016	PASS
Conducted Output Power			PASS
Peak-to-average ratio			PASS
99%&26 dB Bandwidth			PASS
Band Edge at antenna terminals			PASS
Spurious emissions at antenna terminals			PASS
Field strength of spurious radiation			PASS
Frequency stability			PASS

Ublox

Transportation Requirements	Shock, severe vibration, and moisture should be avoided in transportation	
Frequency Bands	Bands ¹ 2, 3, 4, 5, 8, 12, 13, 20, 28	
Communication Mode	LTE Cat M1/ NB1	
Effective Radiated Power LTE	LTE Cat M1/ NB1: ≤ +23 dBm (2100 mW), Class 3	
FCC ID	XPY2AGQN4NNN	
Security Measures	Authentication	Enforced on all data channels (outgoing and incoming)
	Encryption	Base 128 encoding

¹ The LTE bands supported by Cellular Module are defined in above, while the following Table 2 describes the Transmitting and Receiving frequencies.

Table 2 Transmitting and Receiving frequencies

Parameter		Min.	Max.	Unit	Remarks
Frequency range FDD Band 12 (700 MHz)	Uplink	699	716	MHz	Module transmit
	Downlink	729	746	MHz	Module receive
Frequency range FDD Band 28 (700 MHz)	Uplink	703	748	MHz	Module transmit
	Downlink	758	803	MHz	Module receive
Frequency range FDD Band 13 (700 MHz)	Uplink	777	787	MHz	Module transmit
	Downlink	746	756	MHz	Module receive
Frequency range FDD Band 20 (800 MHz)	Uplink	832	862	MHz	Module transmit
	Downlink	791	821	MHz	Module receive
Frequency range FDD Band 5 (850 MHz)	Uplink	824	849	MHz	Module transmit
	Downlink	869	894	MHz	Module receive
Frequency range FDD Band 8 (900 MHz)	Uplink	880	915	MHz	Module transmit
	Downlink	925	960	MHz	Module receive
Frequency range FDD Band 4 (1700 MHz)	Uplink	1710	1755	MHz	Module transmit
	Downlink	2110	2155	MHz	Module receive
Frequency range FDD Band 3 (1800 MHz)	Uplink	1710	1785	MHz	Module transmit
	Downlink	1805	1880	MHz	Module receive
Frequency range FDD Band 2 (1900 MHz)	Uplink	1850	1910	MHz	Module transmit
	Downlink	1930	1990	MHz	Module receive

 **WARNING!**

- All other wireless technology emitters must be kept at least 30 cm (12 inches) from the Cellular Module.

CAUTION!

- In accordance with network security requirements, the CPU on this equipment only supports our product software standards and is not compatible with other external software.

7. Available Therapies

The device delivers the following therapies:

CPAP – Delivers Continuous Positive Airway Pressure; CPAP maintains a constant level of pressure throughout the breathing cycle.

AutoCPAP – Delivers CPAP therapy and provides an air pressure no less than the prescribed one based on the patient's needs.

S – A bi-level mode which responds to both your inhalation and exhalation by increasing pressure when you start to inhale and decreasing pressure when you start to exhale. There is no automatic delivery of breathing gas if you do not inhale. IPAP (Inspiratory Positive Airway Pressure) and EPAP (Expiratory Positive Airway Pressure) are preset by physician.

AutoS – A bi-level mode which responds to both your inhalation and exhalation. The differential pressure of IPAP and EPAP are preset by physician. While working in auto feature, the device will automatically adjust the IPAP and EPAP if it detects a sleep apnea.

8. Glossary

Apnea

A condition marked by the cessation of spontaneous breathing.

AutoCPAP

Adjust CPAP pressure automatically to improve patient comfort based on monitoring of sleep events, such as apnea and hypopnea.

Auto Off

When this feature is enabled, the device automatically discontinues therapy whenever the mask is removed.

Auto On

With this feature, the device automatically initiates therapy when you breathe into the mask. This feature is always enabled.

SmartC

With this feature, the device adjusts Treat P according to the patient's respiratory event during a certain time.

SmartA

With this feature, the device adjusts Ramp P and Min APAP according to the patient's respiratory event during a certain time.

SmartB

With this feature, the device adjusts Ramp P and Min APAP according to the patient's respiratory event during a certain time.

CPAP

Continuous Positive Airway Pressure.

EPAP

Expiratory Positive Airway Pressure.

IPAP

Inspiratory Positive Airway Pressure.

iCode

A feature that is intended to give access to compliance and therapy management information. The "iCode" consists of six separate codes displayed in the Patient Menu, each code is a sequence of numbers. The "iCode QR+" display two-dimensional codes.

LPM

Liters Per Minute.

OSA

Obstructive Sleep Apnea.

Patient Menu

The display mode in which you can change patient-adjustable device settings, such as the starting pressure for the Ramp feature.

Ramp

A feature that may increase patient comfort when therapy is started. It begins from a low pressure and then gradually increases to the prescribed setting pressure so that the patient can fall asleep more comfortably.

Rise Time

The time it takes for the device to change from EPAP to IPAP. You can adjust this time for your comfort.

Res Rate

Respiratory Rate. Number of breaths per minute.

Reslex

A therapy feature that is enabled by your physician to provide pressure relief during exhalation.

Standby State

The state of the device when power is applied but the airflow is turned off.

min

Means the time unit "minute".

h

Means the time unit "hour".

yy mm dd / mm dd yy / dd mm yy

Denotes date.

9. Model

Model	Product Contents		Mode	Maximum Working Pressure (cmH ₂ O)
	Main Device	Accessories		
LG3700	Main device (3.5-inch TFT)	Power Adapter, Power Cord, Tubing (optional), Cellular Module (optional), Heated Tubing (optional)	CPAP, AutoCPAP, S, AutoS	25

10. Package Contents

After unpacking the system, make sure you have everything shown here:

No.	Articles	Qty.	Notes
1	Main Device	1	
2	Power Adapter	1	
3	Power Cord	1	
4	Tubing Elbow Adapter	1	Optional
5	Tubing	1	Optional
6	Heated Tubing	1	Optional
7	Reusable Air Filter	1	
8	Disposable Ultra-Fine Filter	3	Optional
9	SD Card	1	Optional
10	Cellular Module	1	Optional
11	Carrying Case	1	
12	Accompanying Documents	1	
13	Power Cord Locker	1	

All parts and accessories are not made with natural rubber latex.

The expected service life of the device is five years from first date of use, if the use, maintenance, cleaning and disinfection are in strict accordance with the User Manual. The shelf life of the device is ten years.

The expected service life of the Tubing and the Heated Tubing is six months from first date of use. The shelf life of the Tubing and the Heated Tubing is 3 years.

The expected service life of the Water Chamber is 6 months from first date of use.

WARNINGS!

- This device should only be used with the mask and accessories manufactured or recommended by REACT HEALTH or with those recommended by your prescribing physician. The use of unsuitable masks and accessories may affect the performance of the device and impair the effectiveness of therapy.
- The use of accessories other than those specified, with the exception of cables sold by the manufacturer of the equipment or system as replacement parts for internal components, may result in increased emissions or decreased immunity of the equipment or system.
- Do not stack up the long tubing at the head of the bed, as it could wrap around the head or neck of the patient during sleep.
- Do not connect any equipment to the device unless recommended by REACT HEALTH or your health healthcare provider.
- Exceeding the Expected Service life, our company cannot guarantee the normal function of the device, nor the safety and effectiveness of the device.

IMPORTANT TIPS!

- If any of the above parts are missing, contact your healthcare provider.
- Contact your healthcare provider for additional information on the available accessories of this device. When using optional accessories, always follow the instructions enclosed with the accessories.

11. System Features

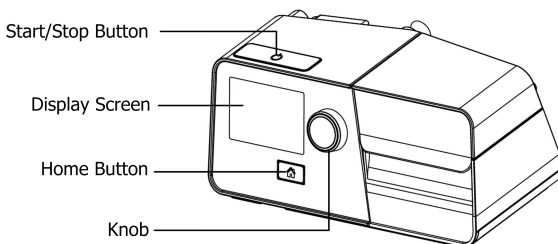

Fig. 11-1

Name	Function
Start/Stop Button	Start/Stop delivering air
Display Screen	Display menus for operation, messages, monitoring data, etc.
Home Button	Return to the previous menu or main interface
Knob	Adjust device settings

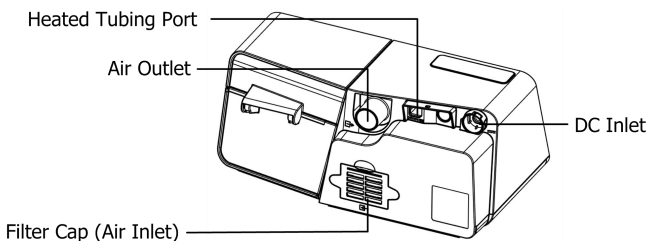

Fig. 11-2

Name	Function
Air Outlet	Deliver pressurized air; connect to the tubing
Heated Tubing Port	Connected to the plug of the heated tubing
DC Inlet	An inlet for the DC power supply
Filter Cap (Air Inlet)	Use cover to secure the air filters used to filter dust and pollen in the air entering the device.

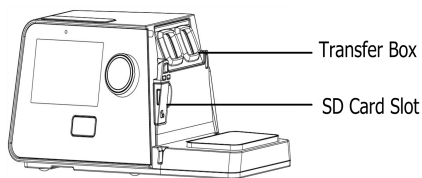

Fig. 11-3

Name	Function
Transfer Box	Connect the device to the water chamber
SD Card Slot	Insert the SD card into this slot

CAUTION!

- The pictures in this manual are only for reference, if they are different from the material object, the latter shall prevail.

12. First Time Setup**12.1 Placing the Device**

Place the device on a firm, flat surface.

⚠ WARNINGS!

- If the device has been dropped or mishandled, if the enclosure is broken, or if water has entered the enclosure, disconnect the power cord and discontinue use. Contact your healthcare provider immediately.
- If the room temperature is warmer than 95°F (35°C), the airflow produced by the device may exceed 109.4°F (43°C). The room temperature must be kept below 95°F (35°C) while the patient uses the device.

CAUTIONS!

- Always ensure that the device is placed in an area where the screen and indicators are clearly visible.
- If the device has been exposed to either very hot or very cold temperatures, allow it to adjust to room temperature (approximately 2 hours) before beginning setup.
- Make sure the device is away from any heating or cooling equipment (e.g. forced air vents, radiators, air conditioners).
- The device is not suitable for use in high humidity environments. Make sure that no water enters the device.
- Make sure that bedding, curtains, or other items are not blocking the filter or vents of the device.
- Keep pets, pests or children away from the device and avoid small objects being inhaled or swallowed.

- To prevent the risk of explosion, this device must not be used in the presence of flammable gases (e.g. anesthetics).
- Tobacco smoke may cause tar build-up within the device, leading to the malfunctioning of the device.
- Air must flow freely around the device for it to work properly.
- Empty the water chamber completely before moving the device.
- If condensation is present in the tube, remove and drain the tube. Lower the humidifier setting level.

12.2 Installing the Reusable Air Filter / Optional Disposable Ultra-Fine Filter and Filter Cap

(1) Attach the reusable air filter to the filter cap, as shown in Fig. 12-1.



Fig. 12-1

(2) If the disposable ultra-fine filter is applied, place the reusable air filter first, the reusable air filter should be closest to the filter cap and the disposable ultra-fine filter should be closest to the device, as shown in Fig. 12-2.

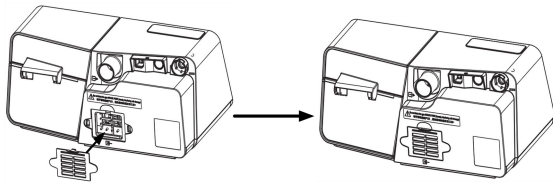

Fig. 12-2

(3) Install the filter cap containing the reusable air filter / disposable ultra-fine filter to the device, as shown in Fig. 12-3.

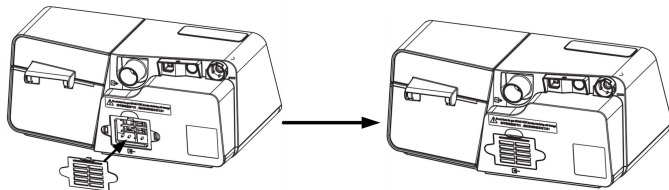

Fig. 12-3

⚠ WARNINGS!

- Do not block the air inlet, thereby interfering with the therapy.
- Nebulization or humidification can increase the resistance of breathing system filters and the operator must monitor the breathing system filter frequently for increased resistance and blockage to ensure the delivery of the therapeutic pressure.
- Please change the reusable air filter regularly and don't block it.
- Fire, open ignition source and smoking prohibited. (Refer to *18.1.6 Cleaning and Replacing the Reusable Air Filter / Optional Disposable Ultra-Fine Filter*)
- Air filters provided by the manufacturer are recommended for use, otherwise foreign objects or odors may enter the device.

CAUTION!

- Device must be unplugged when install the filter and filter cap.

12.3 Connecting to Power

- (1) Insert the plug of the power adapter into the DC Inlet on the back of the device.
- (2) Connect the power cord to the power adapter.
- (3) Plug the other end of the power cord into the power outlet.

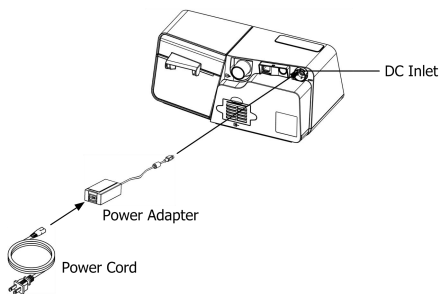



Fig. 12-4

Note: The length of the power cord and power adapter is 1.5 m and 1.8 m respectively without the function of preventing electromagnetic interference.

⚠ WARNINGS!

- The device is powered on for use when the power cord and power adapter is connected. Click the **Start/Stop Button**  to turn on the blower. Press and hold the **Start/Stop Button**  for a moment to turn off the blower.
- Use of the device at an AC voltage beyond the stated range (see Section 6 "AC Power Consumption") may damage the device or cause device failure.
- Connect to appropriate power for proper operation of the device.
- Inspect the power cord often for any signs of damage. Replace a damaged cord immediately.

IMPORTANT TIPS!

- After interruption and restoration of the power supply, the device will restore its pre-interruption working status automatically.
- To remove AC power, disconnect the power cord from the power outlet.

12.4 Connecting to Power Cord Locker

(1) Connect the device to power according to *12.3 Connecting to Power*.

(2) Clip the narrow end of the power cord locker to the cord of the power adapter, as shown in Fig. 12-5.

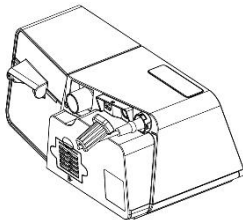

Fig. 12-5

(3) Insert the power cord locker into buckle of DC inlet, as shown in Fig. 12-6.

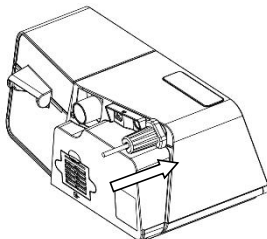

Fig. 12-6

(4) Press the power cord locker downward to fix power cord into the port, as shown in Fig. 12-7.

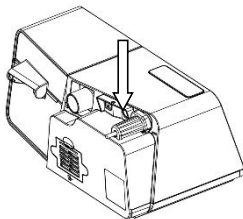

Fig. 12-7

The function of the locker is to prevent the power cord falling out of the power port. After

installation, you must make sure that the power adapter cable is stuck in the slot at the narrow end of the power cord locker.

12.5 Assembling the Tubing / Heated Tubing and Mask

(1) Connect one end of the tubing to the air outlet of the device, as shown in Fig. 12-8.

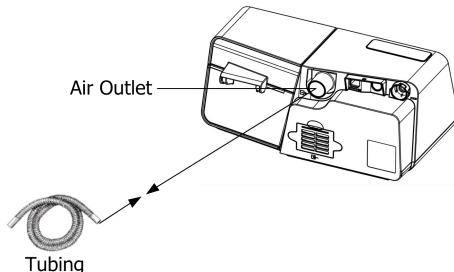

Fig. 12-8

(2) Or if the heated tubing is applied, connect the heated tubing joint to the air outlet of the device, and then insert the power plug of the heated tubing into the heated tubing port on the back of the device, as shown in Fig. 12-9.

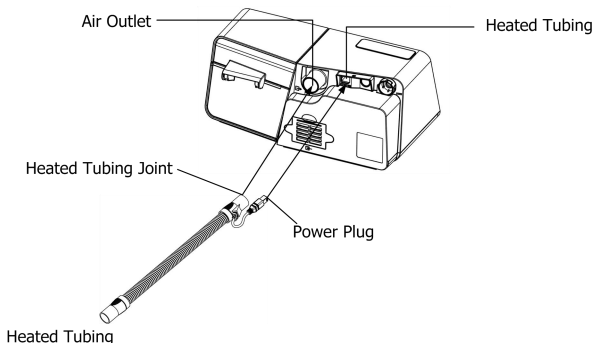



Fig. 12-9

CAUTION!

- You may experience condensation or moisture build-up in your patient tubing due to cold ambient room temperature and high humidifier output. Reducing your humidifier setting, using a heated tube, or increasing your heated tube setting can help reduce the condensation build-up.

If the heated tubing is connected correctly, the icon  will become a number in the Main Interface on the screen of the device, as shown in Fig. 12-10.

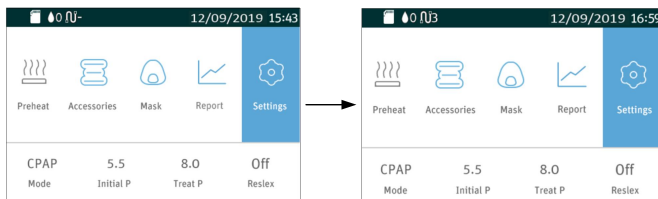



Fig. 12-10

Turn **the Knob**  to turn on or turn off the heated tubing and to adjust the heat level according to instructions of the Patient Menu of the device.

There are five heat levels available, and the number of heat level will appear in the Main Interface on the screen of the device. The number 3 next to the icon  indicating the heat is adjusted to Level 3, as shown in Fig. 12-11.



Fig. 12-11

(3) To apply the tubing elbow adapter, connect the tubing elbow adapter between the device air outlet and the tubing (heated or standard tubing) as shown in Fig. 12-12. The 90-degree elbow helps to direct the tubing.

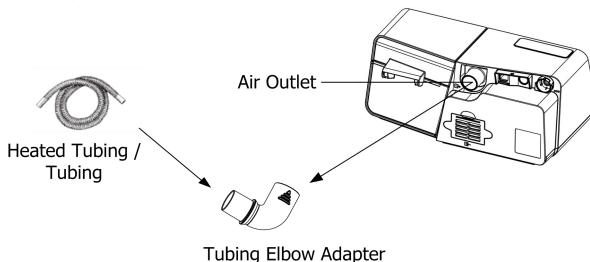

Fig. 12-12

(4) Connect the other end of the tubing / heated tubing to the mask according to the user manual of the mask.

WARNINGS!

- If multiple persons are going to use the device (e.g. in healthcare facility), a low-resistance, main flow bacteria filter should be installed in-line between the device and the tubing.

Pressures must be verified by your healthcare provider when using spare or optional accessories. Regularly check the bacterial filters in case of increasing breathing resistance or blockages.

- If you are using a mask with a built-in exhalation port, connect the mask's connector to the tubing.
- If you are using a mask with a separate exhalation port, connect the tubing to the exhalation port. Position the exhalation port so that the vented air is blowing away from your face. Connect the mask's connector to the exhalation port.
- If you are using a full-face mask (a mask covering both your mouth and nose), the mask must be equipped with a safety (entrainment) valve.
- In order to minimize the risk of CO₂ rebreathing, the patient should observe the following instructions:
 - Use only tubing and mask provided by REACT HEALTH.
 - Do not wear the mask for more than a few minutes while the device is not operating.
 - Use only masks with vent holes. Do not block or try to seal the vent holes in the exhalation port.

12.6 Using Oxygen with the Device

Oxygen may be added at the mask connection. Please observe the instructions listed below when using oxygen with the device.

WARNINGS!

- Connect the oxygen tube to the oxygen inlet of the mask.
- The oxygen supply must comply with the local regulations for medical oxygen.
- Turn on the device before turning on the oxygen. Turn off the oxygen before turning off the device. Explanation of Warning: When the device is turned off, but the oxygen flow still exists, oxygen may accumulate within the device's enclosure and pose a fire hazard. Turning off the oxygen before turning off the device will prevent oxygen accumulation in the device and reduce the risk of fire. This warning applies to all CPAP devices.
- Oxygen supports combustion. Keep the device and the oxygen container away from heat, open flames, any oily substances, or other sources of ignition. DO NOT smoke in the area near Luna® G3 BPAP 25A System or the oxygen container.
- Sources of oxygen should be located more than 1 m from the device.
- When using oxygen with this system, a Pressure Valve must be placed in-line with the patient circuit between the device and the oxygen source. The pressure valve helps prevent the backflow of oxygen from the patient circuit into the device when the unit is off. Failure to use the pressure valve could result in a fire hazard.
- When the pressure valve is installed, the Auto On function on the device will not work. To turn on the device either breath into your mask or select the On/Off button.
- Supplemental oxygen must not be used while smoking or in the presence of an open flame.
- When using the device with an oxygen supply, check the following:

Starting therapy - ensure the device is on and blowing air before the oxygen supply is turned on.

Stopping therapy - ensure the oxygen supply is turned off first, then the device.

This will ensure oxygen does not accumulate within the device and create a risk of fire.

- Do not connect the device to an unregulated or high-pressure oxygen source. The pressure of oxygen source does not exceed the work pressure of the device.

12.7 Inserting the SD Card (Only for the device that equipped with SD card)

Insert the SD card into the SD Card Slot, as shown in Fig. 12-13.

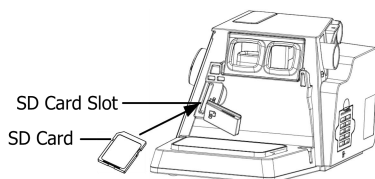



Fig. 12-13

If the SD card is inserted correctly, a symbol  indicating correct insertion will appear in the Main Interface on the screen of the device.

If the SD card is inserted incorrectly, a symbol  indicating incorrect insertion will appear in the Main Interface on the screen of the device.

CAUTIONS!

- If the SD card is not inserted, the symbol will not appear in the Main Interface on the screen of the device.
- To avoid data loss or any damage to the SD card, the SD card should only be removed after the device stops delivering air.

12.8 Starting Treatment

Connect the device to a power outlet, press the **Start/Stop Button**  and the device will start delivering air.

! WARNINGS!

- Be sure that your healthcare provider follows your physician's instructions on adjusting the settings! These settings should not be tampered with by the patient. To order any accessories not included with this device, contact your healthcare provider.
- DO NOT connect any ancillary equipment to this device unless recommended by REACT HEALTH or your physician. If you suffer from chest discomfort, shortness of breath, stomach bloating, or severe headache when using the device, contact your physician or qualified medical personnel immediately.

13. Routine Use

13.1 Connecting the Tubing

Connect the power cord, power adapter, and tubing properly according to the instructions in the First Time Setup (Chapter 12). Connect the mask and headgear according to the user manual for the mask.

CAUTION!

- Before each use, examine the tubing for any damage or debris. If necessary, clean the tubing to remove the debris. Replace any damaged tubing. Make sure that the mask does not leak.

13.2 Adjusting the Tubing

Lie down on your bed and adjust the tubing so it is free to move if you turn over during sleep. Adjust the mask and headgear until you have a comfortable fit with no airflow leaks around the mask.

13.3 Turning on the Airflow

Press the **Start/Stop Button**  to turn on the airflow. The screen will display treatment pressure and other information.

13.4 Heating the Water

Pay attention to the number next to the icon  when using the humidifier. The number indicate the **On/Off** state of the humidifier. It is off when the number next to the icon is 0.

CAUTION!

- Observe the water level of the water chamber before using the humidifier. Make sure there is sufficient water in the water chamber and avoid heating the device with an empty water chamber.

13.5 Using the Ramp Feature

Every time the feature is enabled, the pressure will drop to the set initial pressure, and then gradually rise to the prescribed treatment pressure according to the preset ramp time, to ensure patient comfort. The screen displays a real-time countdown of the remaining ramp time in minutes.

CAUTIONS!

- You can use the ramp feature as often as you wish during sleep.
- The ramp feature is not prescribed for all users.

13.6 Accessing the iCode



After the device is powered on, move the cursor to the icon  by turning **the Knob** , as shown in Fig. 13-1. Access the iCode information by pressing **the Knob** , the screen displays the iCode Interface, as shown in Fig. 13-2.



Fig. 13-1



Fig. 13-2

13.7 Turning the Device Off

Take off the mask and headgear, press the **Start/Stop Button** , and the device will stop delivering air. Disconnect the power cord from the power outlet to power off the device.

CAUTION!

- Do not position the device where it is difficult to disconnect the power cord from the power outlet to power off the device.

14. Heated Humidifier

The humidifier is available from your healthcare provider. The humidifier may reduce nasal dryness and irritation by adding moisture (and heat if applicable) to the airflow.

14.1 Filling the Water Chamber

14.1.1 Removing the Water Chamber

Press down the water chamber on the part closest to the machine and then remove it, as shown in Fig. 14-1.

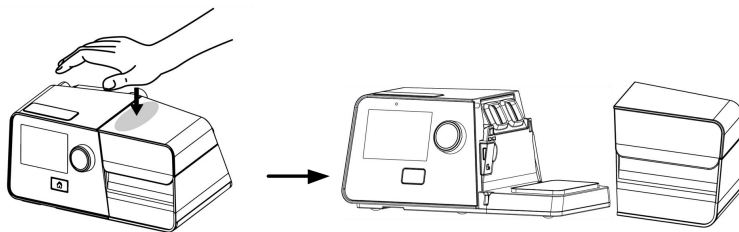

Fig. 14-1

⚠ WARNING!

- Turn the device off and allow the heating plate and water to cool for approximately 15 minutes before remove the Water Chamber.

14.1.2 Filling Water

(1) Remove the water chamber, open the cap, as shown in Fig. 14-2, and fill the water chamber with approximately 360 mL of distilled water (recommended), as shown in Fig. 14-3. Make sure that the water does not exceed the maximum water level line.

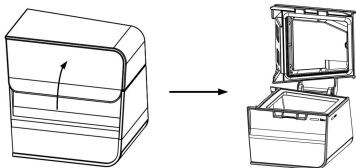

Fig. 14-2

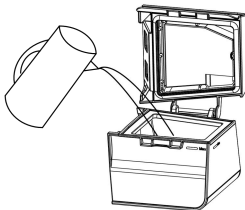

Fig. 14-3

⚠ WARNING!

- Change water before every use and do not exceed the maximum water level line.

CAUTIONS!

- Empty the water chamber when the heated humidifier is not in use.
- Distilled water is recommended.

IMPORTANT TIP!

- It is not necessary to remove the water chamber from the device. The users can open the cap of the water chamber directly to fill the water.

14.1.3 Returning the Water Chamber

Close the cap after it is filled with water, as shown in Fig. 14-4, and return it to the device, as shown in Fig. 14-5.

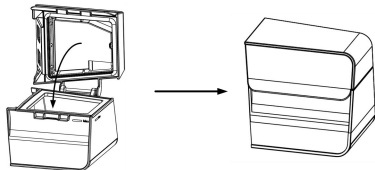

Fig. 14-4

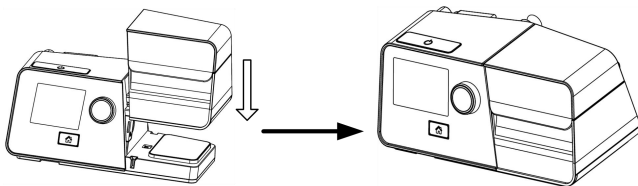

Fig. 14-5

⚠ WARNING!

- For safety purposes, the device must be placed on a flat surface at a level lower than the patient's head on a bed, so that the condensation flows back to the water chamber rather than remain in the tubing causing rainout.

CAUTIONS!

- Avoid moving or tilting the device when the water chamber has water in it.
- Take precautions to protect furniture from water damage.

14.2 Emptying the Water Chamber

- (1) **Removing the water chamber** according to instructions in 14.1.1.
- (2) **Emptying the water chamber:** Open the cap, as shown below, and pour any remaining water out of the water chamber.

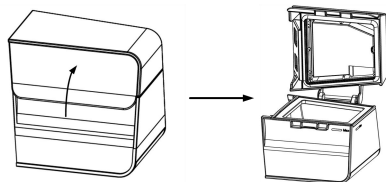



Fig. 14-6

CAUTION!

- Empty and air-dry the water chamber when the device is not in use.

(3) **Returning the Water Chamber** according to instructions in 14.1.3.

14.3 Setting the Humidity Level

After the device is powered on, turn **the Knob**  to turn on or turn off the heated humidifier and to adjust the humidity level according to instructions of the Patient Menu of the device.

There are five humidity levels available, and the number of humidity level will appear in the Main Interface on the screen of the device. The number 2 next to the icon  indicating the humidity is adjusted to Level 2, as shown in Fig. 14-7. The temperature of the water in the water chamber maintains a constant set level.

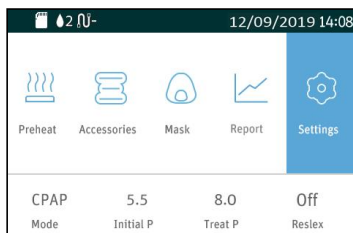

Fig. 14-7

⚠ WARNING!

- Do not touch the heater plate of the device when it is working, otherwise you may get burned. Turn off the heat when the heated humidifier is not in use.

CAUTIONS!

- Generally speaking, the humidity inside the mask is low when the water temperature is low.
- Condensation inside the tubing is more likely to occur as the difference between the air tubing temperature and room temperature increases.
- If there are only a few condensed water droplets inside the tubing in the morning after therapy, it means that the humidity level is appropriate; if there is a lot of condensed water droplets inside the tubing and / or mask, it means that the humidity level is too high and should be set lower. Nasal or oral dryness means that the humidity level is too low and should be set higher.

15. Using the Cellular Module

The Luna® G3 BPAP 25A with a Cellular Module can wirelessly communicate with the iCodeConnect cloud platform. iCodeConnect cloud platform is intended to augment the standard follow-up care of patients diagnosed with obstructive sleep apnea by displaying usage and therapeutic information that has been transmitted from the patient's Luna® G3 BPAP 25A therapy device to the clinician or healthcare professional.

(1) Insert the Cellular Module into the device and turn on the device. The device screen displays the Main Screen shown in Fig. 15-1.



Fig. 15-1

(2) The Cellular Module starts searching for signals in a few seconds. Once a signal is found, the module will automatically connect to it, and a signal icon will appear in the status bar at the top of the device screen.

There are four different signal icons, as listed in Table 3:

Table 3 Description of Signal Icons

Icon	Description
	Strong signal
	Moderate signal
	Weak signal
	No signal found

Notes:

- (1) When the signal is weak, data transmission may become slow and even stop.
- (2) The Cellular Module will keep searching for signals until one is found.

If the signal is strong, the signal icon appears in the Main Screen, as shown in Fig. 15-2 (the signal icons of different strength appear in a similar way).



Fig. 15-2

The device screen will not show the signal if the Cellular Module is connected to the device improperly or if the Module is not working properly.

⚠ WARNING!

- To ensure successful data transmission through the Cellular Module, computers, televisions, radios or similar devices should not be placed near the Cellular Module.

16. Navigating the Patient Menu**16.1 Steps to Navigate the Patient Menu****16.1.1 Accessing the Main Interface**

Connect the power cord and power adapter, the screen will display the Main Interface shown in Fig. 16-1. Press **Start/Stop Button** , and the device will start delivering air, the screen displays the Main Interface shown in Fig. 16-2.

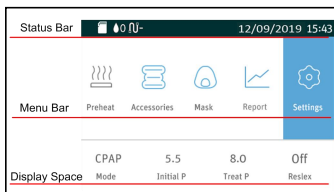

Fig. 16-1

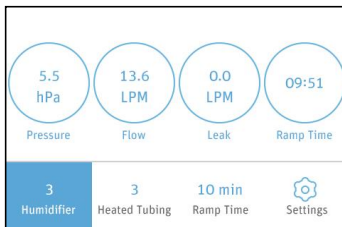

Fig. 16-2

Note: The above interface is only applicable to the device, it does not activate the SmartC, SmartA or SmartB. If the SmartC, SmartA or SmartB is enabled, the symbol **S** will appear in the status bar at the top of the screen, as shown in Fig. 16-3.

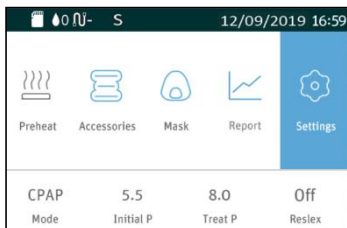







Fig. 16-3

The first icon  on the upper part of the screen indicates the Preheat Function Icon, the

second  indicates the Accessories, the third icon  indicates Mask Setup, the fourth icon  indicates the Report Interface, and the fifth icon  indicates the Initial Setup. As you turn **the Knob** , the cursor switches among the five icons, and the interface displayed on the screen changes accordingly.

Note: If the humidity level is off, the Preheat Icon  will Turn gray, as shown in Fig. 16-3.

16.1.2 Bringing up the Initial Setup Interface



After the screen displays the Main Interface shown in the Fig. 16-1, turn **the Knob** . When the cursor is on the icon , press **the Knob** , the screen displays the Initial Setup Interface of the Patient Menu, as shown in Fig. 16-4.



Fig. 16-4

Note: The **Heated Tubing** option can only be adjusted when the device is connected to the Heated Tubing, as shown in Fig. 16-5.



Fig. 16-5

16.1.3 Selecting Options



As you turn **the Knob**  clockwise, the cursor moves downwards from one option to another. When the cursor is on the desired option, press **the Knob** , and the background color of the option will change, meaning that the option can now be adjusted, as shown by the **Humidifier** option in Fig. 16-6.



Fig. 16-6

16.1.4 Adjusting Options





Adjust the option by turning **the Knob** . As shown in Fig. 16-7, the **Humidifier** option is selected. As you turn **the Knob**  clockwise, the numerals increase, indicating a higher humidity level. As you turn **the Knob**  counterclockwise, the numerals decrease, indicating a lower humidity level.



Fig. 16-7

16.1.5 Confirming Adjustments

Confirm your adjustment to an option by pressing **the Knob** . The option is then displayed in white, as shown in Fig. 16-8.

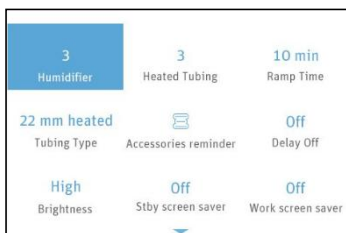

Fig. 16-8

16.1.6 Turning Pages





When the cursor is on **Work screen saver**, the last option shown in Fig. 16-8, the remaining options will appear on a new page if you continue to turn **the Knob**  clockwise, as shown in Fig. 16-9.









Fig. 16-9

Note:   are page turning symbols.

16.1.7 Exiting the Patient Menu

The users can press the **Home Button**  to return to the Main Interface shown in Fig. 16-1.

16.2 Options of the Patient Menu and Corresponding Descriptions

Option	Range	Description
Humidifier	Off, Auto, 1 ~ 5	There are five humidity levels available. As the numbers increase, the humidity rises accordingly. "Off" means the humidifier is turned off.
Preheat	On / Off	Set humidifier to preheat by adjusting this option. This feature automatically turns off after 30 minutes.
Reslex	Off, 1 ~ 3	This feature enables the device to automatically reduce the treatment pressure when the patient exhales, so as to make the user more comfortable. The higher the number is, the more pressure the device reduces. "Off" means this feature is disabled.
Heated Tubing	Off, 1 ~ 5	There are five heat levels available. As the number increases, the heat rises accordingly. "Off" means the heat is turned off. Note: Heated Tubing is displayed in the patient menu only when it is connected.
Ramp Time	Auto, 0 ~ Max Ramp	In order to increase comfort and help the patient fall asleep easily, the pressure can increase gradually when the Ramp feature is enabled. The ramp time during which the initial pressure rises to the prescribed treatment pressure can be adjusted. As you turn the Knob  to the nearest point, the numbering increases or decreases by five minutes. The screen displays a real-time countdown of the remaining ramp time in seconds.
Delay	On / Off	When the humidifier is on, this feature allows the airflow to continue for about 15 minutes at a low pressure (about 2 cmH ₂ O) after you press the Start/Stop Button  to discontinue treatment. This will blow off the vapor left in the water chamber to avoid any damage to the device. When this feature is set to "Off", which means it is disabled, the air flow stops delivering air instantly after you press the Start/Stop Button  .
Time	00:00 — 23:59	Set time by adjusting this option.
Time Format	12-hour / 24-hour	Turn the Knob  to choose between the two time formats.
Date Format	yy mm dd / mm dd yy / dd mm yy	Turn the Knob  to choose among three date formats.
Backlight	Auto / On	The backlight of the LCD screen can be set to "Auto" or "On". Turn the Knob  to choose between the two modes. If it is set to "Auto", the backlight will turn off automatically after 30 seconds of inactivity.

		If it is set to "On", the backlight will always be on.
Mask Fitting Test	Start the Mask Fitting Test	Test whether the mask is worn correctly, the screen will display the "great" icon if it passes the fit test, otherwise the screen will display the "need to adjust" icon.
Brightness	High / Low	Set screen brightness by adjusting this option.
Mask Type	Full Face / Nasal / Pillow / Other	There are three mask types available, Full Face (full-face mask), Nasal (nasal mask), and Pillows (nasal pillows mask). The default mask type is " Nasal ", but the patient can choose other suitable masks as well. When the user selects masks other than the above three types of REACT HEALTH masks, the patient can identify the masks as other.
iCode	iCode / iCode QR+	iCode provides access to the patient's compliance data during a recent time. The iCode mode displays data in sequences of numbers, and the iCode QR+ mode displays data in two-dimensional codes.
Accessories	—	Reset the use time of the filter, tubing and mask.
Accessories Reminder	30 days / 60 days / 180 days / 1 year / Off	This function is used for setting the replacement reminder of the air filter, tubing and the mask.
Language	English	The default setting is " English ".
Use Time	0 ~ 50000 h	Use Time displays how long the device been used by the patient. The use time can be restored to factory settings.
About	—	Displays related information of the device (Model, SN, Version, ID). This is read-only and cannot be edited.

17. Alert

Alert Message	Description
Power Failure!!!	<p>An audible alert will sound in 6 s if the device is accidentally disconnected from power when it is delivering air.</p> <p>Notes:</p> <p>(1) The alert will not sound if power failure occurs when the device is in standby state.</p> <p>(2) No alert message displayed during a power failure.</p>
Device Fault!!!	<p>An audible alert will sound if no airflow comes out of the machine; the screen will display "Device Fault!!!".</p>
Leak!!	<p>When the airflow is on, an audible alert will sound if the air leak rate exceeds 150 L/min; the screen will display "Leak!!".</p>
Low Input Voltage!!	<p>If the voltage supplied by power adaptor is lower than 22 V, an audible alert will sound, and the screen will display "Low Input Voltage!!".</p>
Humidifier Failure!!	<p>When humidifier is connected, an audible alert will sound if the humidifier fails to work in 10 minutes; the screen will display "Humidifier Failure!!".</p>
Please Change Filter!	<p>When the Filter Alert feature is enabled, an audible alert will sound if the preset replacement time is reached but the filter hasn't been replaced; the screen will display "Please Change Filter!".</p>
Please Replace Tubing!	<p>When the tubing Alert feature is enabled, an audible alert will sound if the preset replacement time is reached but the tubing hasn't been replaced; the screen will display "Please Replace Tubing!".</p>
Please Replace Mask!	<p>When the Mask Alert feature is enabled, an audible alert will sound if the preset replacement time is reached but the mask hasn't been replaced; the screen will display "Please Replace Mask!".</p>
SD Card Full!	<p>The screen will display "SD Card Full!" if the SD card has reached its maximum capacity.</p>
Reinsert SD card!	<p>The screen will display "Reinsert SD Card!" if the SD card fails to work.</p>

18. Cleaning and Disinfection

WARNINGS!

- Cleaning and disinfection can be performed by the patient.
- Cleaning and disinfection of the device and its accessories as recommended in the following sections is essential to prevent respiratory infections.
- To avoid electric shock, always unplug the device before cleaning and disinfection.
- Follow the manufacturer's instructions on cleaning the mask and tubing and on determining the frequency of cleaning.
- Before cleaning and disinfection, check that the device is disconnected from the power supply, whether the power cord is unplugged, and whether the water chamber of the device has cooled down. Make sure that the heating plate has cooled down to room temperature, so that you do not get burned.
- Do not open or modify the device. There are no operator serviceable parts inside. Repairs and service should only be performed by an authorized service agent.
- In order to prevent contamination of the device, use only manufacturer-approved filters on this device conforming to ISO 23328-1:2003 and ISO 23328-2:2002 standards.
- The device shall not be serviced or maintained while a patient is using it.
- After disinfection, rinse any disinfected component in clean water thoroughly, to prevent disinfectant residuals from damaging the skin or respiratory tract or causing allergies.
- Avoid the use of any CPAP cleaner or disinfection device that relies on ozone (i.e. activated oxygen). The device warranty may terminate if the damage is caused by the use of an ozone cleaner.
- Disinfection of this device and its components other than as recommended by the manufacturer is not permitted.
- To prevent cross-infection of patients or contamination of the device, a BSF (Breathing System Filter) that meets the standards of ISO 23328-1:2003 and ISO 23328-2:2002 and has medical device registration certificates can be used.
 - (1) A new BSF is required for different patients before using this device.
 - (2) When using the BSF, please follow the instructions of the BSF for installation and operation, and pay attention to adjusting the output pressure setting of the device according to the resistance of the BSF to ensure that proper treatment pressure can be provided.
 - (3) Humidification will increase the resistance of the BSF. The operator must frequently monitor the BSF for increased resistance and blockage to ensure that proper treatment pressure can be provided.
- If you use ozone or other cleaning and disinfection methods not recommended by REACT HEALTH, REACT HEALTH will not be able to verify the safety or performance of the device.

CAUTIONS!

- Overheating of the materials could lead to early wear of the materials.
- Do not use solutions containing chlorinated lime, chlorine, or aromatic to clean the device and its accessories. Liquid soap containing moisturizing agents or antimicrobials should not

be used, either. These solutions may harden cleaned materials or reduce their lifespan.

- Do not clean or dry the device and its accessories when the temperature is above 80°C (176°F). High temperatures could reduce product life.
- Do not immerse the device in any fluids.
- The disposable ultra-fine filter should not be cleaned or reused.
- Disinfectants tend to damage the materials and reduce the life of components. Use manufacturer recommended disinfectants (section 18.2 below) and follow the manufacturer's instructions and recommendations.
- After disinfection, check the disinfected component for any signs of damage. Replace any damaged component immediately.

18.1 Cleaning

Accessories that need to be cleaned	Detergent	Water temperature
Water chamber	Alconox (diluted at 1%)	Warm water (approx 113 to 140°F or 45 to 60°C)
Transfer box	Alconox (diluted at 1%)	Warm water (approx 113 to 140°F or 45 to 60°C)
Reusable Air Filter	-	The tap water 5°C to 35°C (41°F to 95°F)

18.1.1 Cleaning the Water Chamber

(1) **Opening the Water Chamber:** Open the cap of the water chamber, as shown in Fig. 18-1.

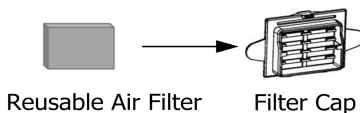

Fig. 18-1

(2) **Cleaning the Water Chamber:** Dilute Alconox to 1% with water 45°C to 60°C (113°F to 140°F). Soak the water chamber in the detergent for 5 minutes. Clean the water chamber with a soft bristled brush for one minute. Pay particular attention to all gaps and cavities. Then rinse the water chamber with running water for 5 minutes. Wipe it dry with a soft cloth or air dry it away from direct sunlight.

(3) **Putting the Water Chamber back:** according to instructions in 14.1.3.

WARNINGS!

- Emptying and cleaning the water chamber daily will help prevent mold and bacteria growth.
- Allow the water in the chamber to cool down to room temperature before removing it from the device.

CAUTIONS!

- Clean the water chamber only after the water in it cools. To make sure that no water enters the device, please disconnect the water chamber from the device prior to cleaning.
- After cleaning, rinse the water chamber thoroughly in clean water to make sure that no soap residue is left; then wipe it dry with a lint-free cloth, to prevent calcareous accumulation.
- Check the water chamber for any leak or damage. Replace the water chamber if there is any damage.
- It is recommended to clean the water chamber and change the water daily.

18.1.2 Cleaning the Transfer Box

(1) **Removing the Transfer Box:** First remove the water chamber from the device, and then remove the transfer box, as shown in Fig. 18-2.

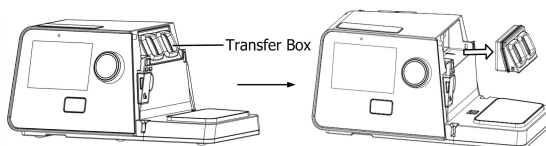

Fig. 18-2

(2) **Cleaning the Transfer Box:** Dilute Alconox to 1% with water 45°C to 60°C (113°F to 140°F). Soak the transfer box in the detergent for 5 minutes. Clean the transfer box with a soft bristled brush for one minute. Pay particular attention to all gaps and cavities. Then rinse the transfer box with running water for 5 minutes. Wipe it dry with a soft cloth or air dry it away from direct sunlight.

(3) **Putting the Transfer Box back:** as shown in Fig. 18-3.

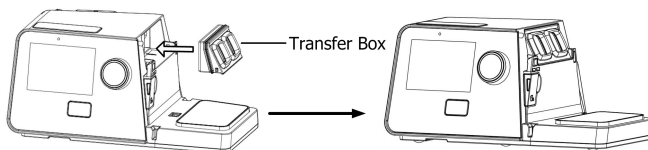

Fig. 18-3

CAUTION!

- It is recommended to clean the transfer box once a week.

18.1.3 Cleaning the Mask and Headgear

For details, refer to the cleaning instructions in the user manual for the mask.

18.1.4 Cleaning the Enclosure

Wipe the enclosure of the device with a soft, slightly damp cloth.

CAUTIONS!

- The device can only be used after the enclosure is dry, so that no moisture enters the device.
- It is recommended to clean the enclosure once a week.

18.1.5 Cleaning the Tubing

- (1) Remove the tubing from the device and mask before cleaning.
- (2) Hold the cuff of the tubing and gently pull it away from the device as shown in Fig. 18-4. Or disconnect the power of the heated tubing, then hold the cuff of the heated tubing and gently pull it away from the device, as shown in Fig. 18-5.

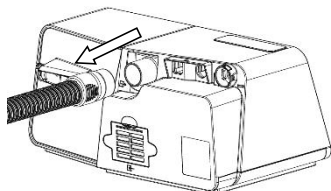

Fig. 18-4

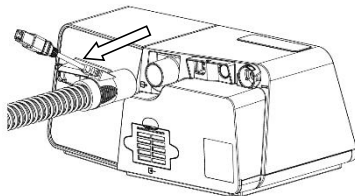

Fig. 18-5

- (3) Hold both the cuff of the air tubing and the swivel of the mask, then gently pull apart as shown in Fig. 18-6.

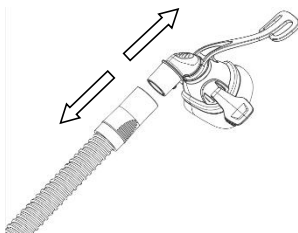

Fig. 18-6

- (4) Soak the tubing in 2% soapy water at 35°C to 40°C for 10 minutes, then clean the inside and outside surfaces with a soft brush for 5 times. Finally, rinse the inside and outside surfaces with distilled water for 3 times, 1 minute each time.
- (5) Gently tap the tubing to remove excess moisture from the connector ports. Hang the tubing so that both ends of the opening face the floor, let the tubing naturally dry, out of

direct sunlight.

(6) Inspection

Carry out a visual inspection of the components. If there are any obvious signs of deterioration (holes, tears or cracks, etc.), these parts should be discarded and replaced. A slight fade may occur, which is acceptable.

⚠ WARNINGS!

- Please clean the tubing by hand.
- The tubing should be cleaned daily.
- If the heated tubing is damaged (such as broken hole, tear, exposed heating wire) or does not function well, please do not repair and use it by yourself, but replace it immediately.
- Failure to clean in accordance with the User Manual may result in reduced performance of the heating tubing or shortened product life.
- After cleaning and before reuse, the tubing should be inspected for holes, creases and tears.

18.1.6 Cleaning and Replacing the Reusable Air Filter / Optional Disposable Ultra-Fine Filter

The reusable air filter should be replaced every 6 months and the disposable ultra-fine filter should be replaced every 2 weeks. Replace the filters more often if there are any holes or blockages by dirt or dust.

(1) To clean or replace reusable air filters, open the filter cap and remove the reusable air filter, place a new reusable air filter into the filter cap, as shown in Fig. 18-7.



Fig. 18-7

(2) If using the optional disposable ultra-fine filter this can be replaced by removing the filter cap and remove the disposable ultra-fine filter. To install a new disposable ultra-fine filter, place the reusable air filter into the filter cap first and then apply the disposable ultra-fine filter. The disposable ultra-fine filter will be closest to the device, as shown in Fig. 18-8.

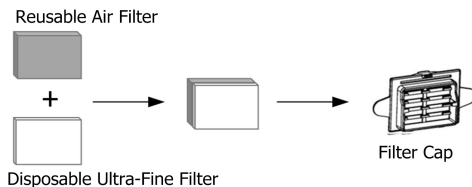

Fig. 18-8

(3) Install the filter cap containing the reusable air filter / disposable ultra-fine filter to the device, as shown in Fig. 18-9.

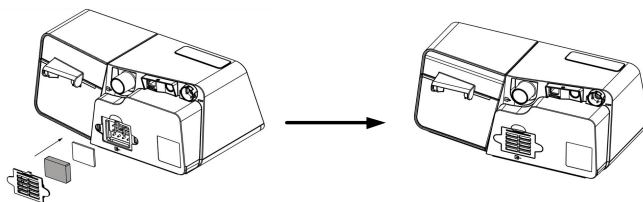

Fig. 18-9

(4) When the reusable air filter is dirty, it can be cleaned as follows:

Hold the reusable air filter and align it with the tap water flow. Rinse the reusable air filter with running water. When cleaning, gently press the reusable air filter, but do not pull on the reusable air filter.

Allow the reusable air filter to air dry completely before reinstalling it.

CAUTION: Never install a wet filter into the device. You must ensure sufficient drying time for the cleaned filter.

The disposable ultra-fine filter is not washable or reusable.

CAUTIONS!

- To avoid material damage, do not place the spare reusable air filter in direct sunlight, humid environments, or temperatures below the freezing point. The reusable air filter should be replaced every 6 months, and the disposable ultra-fine filter should be replaced at least every 2 weeks. Replace the filters more often if there are any holes or blockages by dirt or dust.
- Operating the device with a dirty air filter may stop it from working properly and may cause damage to the device.
- Please replace the manufacturer-recommended filter periodically; Please clean the reusable air filter if it is contaminated.

18.2 Disinfection

Accessories that need to be disinfected	Chemical Disinfection	High Temperature Disinfection
Water chamber	CIDEX® OPA solution at 0.55% concentration Temperature: 20°C	90°C – 92°C water
Transfer box	CIDEX® OPA solution at 0.55% concentration Temperature: 20°C	90°C – 92°C water

Preparation before disinfection

Preparation tools: soft bristle brush, drinking quality water, applicable disinfectant.

Disinfection of the Water Chamber and Transfer Box:

In the following procedures, only one disinfection process needs to be performed at one time.

Chemical Disinfection:

- (1) Clean the water chamber or the transfer box by following the steps in the cleaning instructions.
- (2) Put the CIDEX® OPA solution at 0.55% concentration into a plastic box, so that the water chamber or the transfer box can be completely submerged.
- (3) Immerse the water chamber or the transfer box in CIDEX® OPA solution at 0.55% concentration for 12 min.
- (4) Rinse 3 times the water chamber or transfer box with 8 L purified water to remove the residual disinfectant.
- (5) Wipe the water chamber or transfer box dry with a soft cloth or air dry out of direct sunlight.

High Temperature Disinfection (90°C – 92°C water)

- (1) Clean the water chamber or the transfer box by following the steps in the cleaning instructions.
- (2) Open the cap of the water chamber, and then immerse the water chamber or the transfer box in the water tank. Heat the water and hold between 90°C – 92°C and immerse the water chamber or the transfer box for at least 5min.
- (3) Wipe the water chamber or the transfer box dry with a soft cloth or air dry them away from direct sunlight.

19. Traveling

19.1 Traveling with the Device

- (1) Use the carrying case to carry the device and accessories as a carry on. Do not put them in your checked baggage.
- (2) This device operates on power supplies of 100 V – 240 V and 50 Hz / 60 Hz, and is suitable for use in any country in the world. No special adjustment is necessary, but you will need to find out which power sockets are used in your destination. If necessary, a power socket adaptor can be purchased in electronics stores.
- (3) Remember to bring a spare filter and the emergency documents (filled and signed by your physician) about this device. If you plan to travel by air, remember to bring the multi-language emergency documents about respiratory therapy, in case border and customs officers in your destination country inspect the device. With the emergency documents, you can prove to them that it is a medical device.
- (4) Security Stations: For convenience at security stations, there is a note on the bottom of the device stating that it is medical equipment. It may be helpful to bring this manual along with you to help security personnel understand the device.

CAUTIONS!

- Empty the water chamber before packing the device for your trip; in order to prevent any remaining water from entering the device.
- If the device is used when the atmospheric pressure is out of the stated range (See Section 6), the accuracy of the leakage alert will be affected.

19.2 Traveling by airplane

For some airlines, medical devices do not count toward carry-on luggage limits.

Please check with your airline for their policy regarding medical equipment.

You can use your device on a plane as it meets the Federal Aviation Administration (FAA) requirements.

Aircraft Use

REACT HEALTH confirms that the device meets the Federal Aviation Administration (FAA) requirements (RTCA DO 160, section 20, category T and section 21, category M) for all phases of air travel.

20. Reordering

Contact your healthcare provider to order accessories or replacement filters.

The device does not require routine servicing.

 WARNINGS!

- If you notice any unexplained changes in the performance of the device, if it is making unusual or harsh sounds, if it has been dropped or mishandled, if the enclosure is broken, or if water has entered the enclosure, discontinue use. Contact your healthcare provider.
- If the device malfunctions, contact your healthcare provider immediately. Never attempt to open the enclosure of the device. Repairs and adjustments must be performed by REACT HEALTH -authorized service personnel only. Unauthorized service could cause injury, invalidate the warranty, or result in costly damage.
- If necessary, contact your local authorized dealer or REACT HEALTH, for technical support and documents.

21. Technical Support

Please contact REACT HEALTH directly if you need the circuit diagram of the device and the list of components for certain purposes such as maintenance or connection to other equipment. REACT HEALTH will provide the circuit diagram and / or other technical documents in whole or in part according to your needs.

22. Disposal

Electrical product components contain chemical substance which may pollute environment, when the device reaches the end of its service life, dispose of the device and packaging in accordance with local laws and regulations.

23. Troubleshooting

The table below lists common problems you may have with the device and possible solutions to those problems. If none of the corrective actions solve the problem, contact your healthcare provider.

23.1 Common Problems in Patients and Corresponding Solutions

Problem	Possible Cause	Solution(s)
Dry, cold, runny, and blocked nose; having a cold	The nose reacts to the airflow and cold. Due to airflow, the air becomes cold, leading to nasal mucosa irritation and subsequent dryness and swelling.	Increase the humidity setting of the device. Contact your physician and follow treatment physician suggestions.
Dry mouth and throat	The patient sleeps with his or her mouth open, and the pressurized air goes out via the mouth, leading to nasal and throat dryness.	Use a chin strap to prevent the mouth from opening during sleep, or use a full-face mask. Contact your physician for details.
Eye irritation	The mask size or model may not be correct, or the mask is not positioned correctly, thereby leading to air leakage.	Narrow the distance between the forehead support of the mask and the forehead. Note that adjusting the mask too tight may leave markings on the patient's face. Contact your healthcare provider for an appropriate mask.
	Mask cushion (the soft part of the mask) hardens.	Replace the mask or mask cushion.
Facial reddening	The mask is too tight.	Loosen the headgear.
	The distance between the forehead support of the mask and the forehead is not correct.	Try a different distance. The angle and size of the forehead support differ according to the type of masks.
	Wrong mask size.	Contact your healthcare provider for a correct-size mask.

	The patient may be allergic to the materials of the mask.	Contact your physician and healthcare provider. Use a mask that is not made with natural rubber latex. Place a lining between the skin and mask.
Water in mask	When the humidifier is used, the humidified air tends to condense in the cold tubing and mask if the room temperature is low.	Turn the humidity setting down or raise the room temperature. Place the tubing under the quilt or use the tubing cover. Hang the tubing loosely, the lowest part of the tubing should be lower than the patient's head.
Nasal, sinus, or ear pain	Sinus or middle ear inflammation.	Contact your physician immediately.
Discomfort due to inability to adapt to the treatment pressure	The patient may feel uncomfortable when the treatment pressure is higher than 13 cmH ₂ O. However, the treatment pressure is a prescription and cannot treat sleep apnea if the treatment pressure is set too low.	Patients may experience a variance in time to acclimate to their therapy. If the problem persists, contact your physician or healthcare company for assistance.
Obstructive sleep apnea symptoms reappear	There are many causes of recurring symptoms including weight change, medication or alcohol, and poor mask fit.	Contact your physician for assistance.
The device is too noisy	The tubing is not connected properly.	Reconnect the tubing properly.
Air delivered from the device is abnormally hot	The air inlet of the device may be partially blocked, leading to insufficient airflow into the device.	Replace the filter (refer to 18.1.6 Cleaning and Replacing the Reusable Air Filter / Optional Disposable Ultra-Fine Filter) and clean the air inlet. Place the device in an area where air flows freely, and make sure the device is at least 20 centimeters away from the wall, curtain, or other things.

23.2 Common Problems in the Device and Corresponding Solutions

Problem	Possible Cause	Solution(s)
The device does not work when it is turned on	The Auto On/Off feature is enabled.	Take a few deep breaths with the mask on, and the device will start automatically.
	Power is not connected properly.	Ensure that the power cord, power adapter, and the device are connected properly.
	There is no voltage.	Check whether a power outage occurs by turning on a light or other means. If you are sure the fuse in the device is broken, contact your healthcare provider for repair.
	Cannot find any cause.	Contact your healthcare provider.
The device is working, but the pressure inside the mask differs from the set treatment pressure	The tubing is not connected properly.	Reconnect the tubing properly.
	There may be holes in the mask or pressure sensing tubing.	Contact your healthcare provider.
	It is a faulty device.	Contact your healthcare provider.
The device produces very low pressures	The air inlet of the device may be blocked.	Replace the filter (refer to 18.1.6 Cleaning and Replacing the Reusable Air Filter / Optional Disposable Ultra-Fine Filter), and clean the air inlet. Make sure the air inlet is unblocked.
	The treatment pressure has been changed accidentally.	Contact your physician.
	When the Ramp feature is enabled, it takes some time for the initial pressure to rise to the treatment pressure. This is normal.	If necessary, disable the Ramp feature, or set the ramp time shorter.
After the device is turned on, the screen displays intermittently, or displays nothing at all	The operating system of the device needs to be readjusted or restarted.	Unplug the power cord of the device, and re-plug it 20 seconds later.
The device is in standby, and will not start	The operating system of the device needs to be readjusted or restarted.	Unplug the power cord of the device, and re-plug it 20 seconds later.

24. Information of QoS

QoS is a security mechanism of the network and a technology used to solve problems such as network delay and congestion.

The data transmission between the Luna® G3 BPAP 25A with a Cellular Module and iCodeConnect is a daily transmission. The Cellular Module transmits the following four types of data: Therapy summary data in a defined period, compliance data, system settings, and device information.

This process is not real time communication.

The size of the data transmitted to Cellular Module per second is no more than 1 KB in normal condition, and no more than 1 MB within 8 hours per night.

Acceptable latency

As the user information is not viewed by the physician in real time, sometimes it can be delayed for 24 or more hours.

Acceptable level of probability for loss of information within the network

The data has little effects on treatment effectiveness. These are key data, and their integrity should be ensured, but they do not involve real-time control of therapeutic medical devices, and do not rely on network quality.

Based on the checking mechanism, if the data mentioned above is transmitted incorrectly, then it will be discarded and the correct data will be sent continuously.

The data transmission protocol between the module and the server includes unpacking information and ID value, which ensure the completeness of the data transmission.

Signal priorities of the network

The therapy device itself does not have high-priority medical device alerts, and its treatment of patients does not rely on wireless communications.

Based on the above analysis, the Cellular Module has low requirements for QoS.

25. EMC Requirements

Guidance and manufacturer's declaration - electromagnetic emissions		
The device is intended for use in the electromagnetic environment specified below. The user of the device should ensure that it is used in such an environment.		
Emissions Test	Compliance	Electromagnetic Environment - Guidance
RF emissions CISPR 11	Group 1	The device uses RF energy only for its internal function. Therefore, its RF emissions are very low and are not likely to cause any interference in nearby electronic equipment.
RF emissions CISPR 11	Class B	The device is suitable for use in all establishments including domestic establishments and those directly connected to the public low-voltage power supply network that supplies buildings used for domestic purposes.
Harmonic emissions IEC 61000-3-2	Class A	
Voltage fluctuations / flicker emissions IEC 61000-3-3	Complies	

Guidance and manufacturer's declaration - electromagnetic immunity			
The device is intended for use in the electromagnetic environment specified below. The user of the device should make sure that it is used in such an environment.			
Immunity Test	IEC 60601 Test Level	Compliance Level	Electromagnetic Environment - Guidance
Electrostatic discharge (ESD) IEC 61000-4-2	±8 kV contact ±2 kV, ±4 kV, ±8 kV, ±15 kV air	±8 kV contact ±2 kV, ±4 kV, ±8 kV, ±15 kV air	Floor should be wood, concrete or ceramic tile. If floors are covered with synthetic material, the relative humidity should be at least 30%.
Electrical fast transient / burst IEC 61000-4-4	±2 kV for power supply lines	±2 kV for power supply lines	Mains power quality should be that of a typical commercial or hospital environment.
Surge IEC 61000-4-5	±1 kV Line(s) to line(s)	±1 kV Line(s) to line(s)	Mains power quality should be that of a typical commercial or hospital environment.
Voltage dips, short interruptions and voltage variations on power supply input lines IEC 61000-4-11	0% U_T ; 0.5 cycle At 0°, 45°, 90°, 135°, 180°, 225°, 270° and 315° 0% U_T ; 1 cycle 70% U_T ; 25 / 30 cycle At 0° 0% U_T ; 250 / 300 cycle	0% U_T ; 0.5 cycle At 0°, 45°, 90°, 135°, 180°, 225°, 270° and 315° 0% U_T ; 1 cycle 70% U_T ; 25 / 30 cycle At 0° 0% U_T ; 250 / 300 cycle	Mains power quality should be that of a typical commercial or hospital environment. If the user of the device requires continued operation during power mains interruptions, it is recommended that the device be powered from an uninterruptible power supply or a battery.
Power frequency (50 Hz / 60 Hz) magnetic field IEC 61000-4-8	30 A/m	30 A/m	Power frequency magnetic fields should be at levels characteristic of a typical location in a typical commercial or hospital environment.
Note: U_T is the AC mains voltage prior to application of the test level.			

Guidance and manufacturer's declaration - electromagnetic immunity			
The device is intended for use in the electromagnetic environment specified below. The user of the device should make sure that it is used in such an environment.			
Immunity Test	IEC 60601 Test Level	Compliance Level	Electromagnetic Environment - Guidance
Conducted RF IEC 61000-4-6	3 V 0.15 MHz to 80 MHz 6 V in ISM and amateur radio bands between 0.15 MHz and 80 MHz	3 V 0.15 MHz to 80 MHz 6 V in ISM and amateur radio bands between 0.15 MHz and 80 MHz	Portable and mobile RF communications equipment should be used no closer to any part of the device, including cables, than the recommended separation distance calculated from the equation applicable to the frequency of the transmitter. Recommended separation distance $d = 1.17\sqrt{P}$ $d = 0.35\sqrt{P}$ 80 MHz to 800 MHz $d = 0.70\sqrt{P}$ 800 MHz to 2.5 GHz Where P is the maximum output power rating of the transmitter in watts (W) according to the transmitter manufacturer and d is the recommended separation distance in meters (m). Field strengths from fixed RF transmitter, as determined by an electromagnetic site survey, ^a should be less than the compliance level in each frequency range. ^b Interference may occur in the vicinity of equipment marked with the following symbol: 
Radiated RF IEC 61000-4-3	10 V/m 80 MHz to 2.7 GHz	10 V/m 80 MHz to 2.7 GHz	
Note 1: At 80 MHz and 800 MHz, the higher frequency range applied. Note 2: These guidelines may not apply in all situations. Electromagnetic propagation is affected by absorption and reflection from structures, objects and people.			
^a Field strengths from fixed transmitters, such as base stations for radio (cellular / cordless) telephones and land mobile radios, amateur radio, AM and FM radio broadcast and TV broadcast cannot be predicted theoretically with accuracy. To assess the electromagnetic environment due to fixed RF transmitters, an electromagnetic site survey should be considered. If the measured field strength in the location in which the device is used exceeds the applicable RF compliance level above, the device should be observed to verify normal operation. If abnormal performance is observed, additional measures may be necessary, such as re-orienting or relocating the device. ^b Over the frequency range 150 kHz to 80 MHz, the field strengths should be less than 10 V/m.			

Recommended separation distances between portable and mobile RF communications equipment and the device

The device is intended for use in an electromagnetic environment in which radiated RF disturbances are controlled. The customer or the user of the device can help prevent electromagnetic interference by maintaining a minimum distance between portable and mobile RF communications equipment (transmitters) and the device as recommended below, according to the maximum output power of the communications equipment.

Rated maximum output of transmitter (W)	150 kHz to 80 MHz $d = 1.17\sqrt{P}$	80 MHz to 800 MHz $d = 0.35\sqrt{P}$	800 MHz to 2.5 GHz $d = 0.70\sqrt{P}$
0.01	0.12	0.04	0.07
0.1	0.37	0.12	0.23
1	1.17	0.35	0.70
10	3.70	1.11	2.22
100	11.7	3.50	7.00

Note 1: At 80 MHz and 800 MHz, the higher frequency range applied.

Note 2: These guidelines may not apply in all situations. Electromagnetic propagation is affected by absorption and reflection from structures, objects and people.

For transmitters rated at a maximum output power not listed above, the recommended separation distance d in meters (m) can be estimated using the equation applicable to the frequency of the transmitter, where P is the maximum output power rating of the transmitter in watts (W) according to the transmitter manufacturer.

Recommended separation distances between RF wireless communications equipment					
The device is intended for use in an electromagnetic environment in which radiated RF disturbances are controlled. The customer or the user of the device can help prevent electromagnetic interference by maintaining a minimum distance between RF wireless communications equipment and the device as recommended below, according to the maximum output power of the communications equipment.					
Frequency (MHz)	Maximum Power (W)	Distance	IEC 60601 Test Level	Compliance Level	Electromagnetic Environment - Guidance
385	1.8	0.3	27	27	RF wireless communications equipment should be used no closer to any part of the device, including cables, than the recommended separation distance calculated from the equation applicable to the frequency of the transmitter. Recommended separation distance $E = \frac{6}{d} \sqrt{P}$ Where P is the maximum output power rating of the transmitter in watts (W) according to the transmitter manufacturer and d is the recommended separation distance in meters (m). Field strengths from fixed RF transmitter, as determined by an electromagnetic site survey, should be less than the compliance level in each frequency range. Interference may occur in the vicinity of equipment marked with the following symbol: 
450	2	0.3	28	28	
710	0.2	0.3	9	9	
745					
780					
810					
870	2	0.3	28	28	
930					
1720	2	0.3	28	28	
1845					
1970					
2450	2	0.3	28	28	
5240					
5500					
5785	0.2	0.3	9	9	
Note: These guidelines may not apply in all situations. Electromagnetic propagation is affected by absorption and reflection from structures, objects and people.					

 WARNINGS!

- This device should not be used in the vicinity of other electronic equipment such as diathermy, electrocautery and radio frequency identification (RFID), security systems (such as electromagnetic anti-theft systems and metal detectors), cell phone, transceiver or radio control products. If you must do so, the device should be observed to verify normal operation.
- Use of the device adjacent to or stacked with other equipment should be avoided because it could result in improper operation. If such use is necessary, this equipment and the other equipment should be observed to verify that they are operating normally.
- Use of accessories, transducers and cables other than those specified or provided by the manufacturer of this equipment could result in increased electromagnetic emissions or decreased electromagnetic immunity of this equipment and result in improper operation.
- Portable RF communications equipment (including peripherals such as antenna cables and external antennas) should be used no closer than 30 cm (12 inches) to any part of the Luna® G3 BPAP 25A, including cables specified by the manufacturer. Otherwise, degradation of the performance of this equipment could result.
- This device may be interfered with by other equipment, even if that other equipment complies with CISPR EMISSION requirements.
- The device may be subject to interference by the electromagnetic field of some known or unknown radio frequency transmitters in the environment during use. If interference occurs, please stay away from the interfered electromagnetic environment, or find and turn off the electromagnetic field interference source before continuing to use it.
- When the product is exposed to welding, electrosurgery, defibrillation, X-ray (γ ray), infrared radiation, transient electromagnetic field, including nuclear magnetic resonance (MRI) and radio interference environment, the product may be damaged.
- During operation of the device, due to electrostatic interference, the following phenomena may occur: (1) Temporary loss of function or degradation of performance, such as abnormal screen display. The device will recover to normal after being restarted; (2) Automatic restart of the device. These phenomena will not affect the normal use of the device and will not cause permanent performance degradation or function loss of the device.

26. Limited Warranty

REACT HEALTH warrants that the device shall be free from defects of workmanship and materials and will perform in accordance with the product specifications for a period of two (2) years for main device and three (3) months for all accessories from the date of sale by REACT HEALTH to the dealer. If the product fails to perform in accordance with the product specifications, REACT HEALTH will repair or replace, at its option, the defective material or part. REACT HEALTH will pay customary freight charges from REACT HEALTH to the dealer location only. This warranty does not cover damage caused by accident, misuse, abuse, alteration and other defects not related to material or workmanship.

REACT HEALTH DISCLAIMS ALL LIABILITY FOR ECONOMIC LOSS, LOSS OF PROFITS, OVERHEAD OR CONSEQUENTIAL DAMAGES WHICH MAY BE CLAIMED TO ARISE FROM ANY SALE OR USE OF THIS PRODUCT. SOME STATES DO NOT ALLOW THE EXCLUSION OR LIMITATION OF INCIDENTAL OR CONSEQUENTIAL DAMAGES, SO THE ABOVE LIMITATION OR EXCLUSION MAY NOT APPLY TO YOU.

To exercise the rights under this warranty, contact the local authorized dealers or:

Manufactured for:

REACT HEALTH

5101 Fruitville Rd., Suite 200

Sarasota, FL 34232

T: (863) 226-6285

For additional information, please visit our website at: www.reacthealth.com

Manufacturer:

BMC Medical Co., Ltd.

Room 10, 17F, Building 4, Huiya Plaza, No.16 Lize Road, Fengtai District, 100073 Beijing,
PEOPLE'S REPUBLIC OF CHINA

Tel: +86-10-51663880

URL: en.bmc-medical.com

E-mail: intl@bmc-medical.com

300302M391209